



TENDIFLEX® 360°

TECHNICAL BOOK

DESIGN & SOLUTIONS





PRODUCT BEST FEATURES/ PARTICOLARITÀ DEL PRODOTTO

- 360° POST HEAD ROTATION/
ROTAZIONE DI 360° DELLA TESTA DELLA COLONNINA**
- UNBEATABLE IN TERMS OF DURABILITY AND ROBUSTNESS/
IMBATTIBILE IN TERMINI DI DURATA E ROBUSTEZZA**
- STABLE UP TO 65 DEGREES OF INCLINATION/
STABILE FINO A 65 GRADI DI INCLINAZIONE**
- FLAT BASE TO FACILITATE THE MOVEMENT OF
TROLLEYS AND SUITCASES/
BASE PIATTA PER FACILITARE LO SPOSTAMENTO DI
CARRELLI E VALIGIE**
- STANDARD, MAGNETIC AND FIXED BASES ARE AVAILABLE/
DISPONIBILE CON BASE STANDARD, MAGNETICA E FISSA**
- ERGONOMIC AND MAGNETIC TAPE-END ARE AVAILABLE
DISPONIBILE CON AGGANCO MAGNETICO E ERGONOMICO**
- POSSIBILITY TO CONNECT THE TAPE ON 3 SIDES/
POSSIBILITÀ DI AGGANCO DEL NASTRO SU 3 LATI**
- DIFFERENT BASE DIAMETERS AVAILABLE/
BASI DISPONIBILI CON DIVERSI DIAMETRI**



**UNBEATABLE IN TERMS OF DURABILITY AND ROBUSTNESS/
IMBATTIBILE IN TERMINI DI DURATA E ROBUSTEZZA**

The original TENDIFLEX® SPORT posts represent the ideal solution for delimiting paths in environments with intense pedestrian traffic. The ultra-resistant base makes them unbeatable in terms of durability and robustness. The extensible belt with ergonomic or magnetic tape-end allows the management of multiple pedestrian paths in total safety.

Le originali colonnine con nastro retraibile TENDIFLEX® SPORT rappresentano la soluzione ideale per delimitare i percorsi in ambienti ad intenso traffico pedonale. La base ultrasensistente rende le TENDIFLEX® SPORT imbattibili in termini di robustezza. Il nastro estensibile con aggancio ergonomico o magnetico consente la gestione di molteplici percorsi pedonali in totale sicurezza.

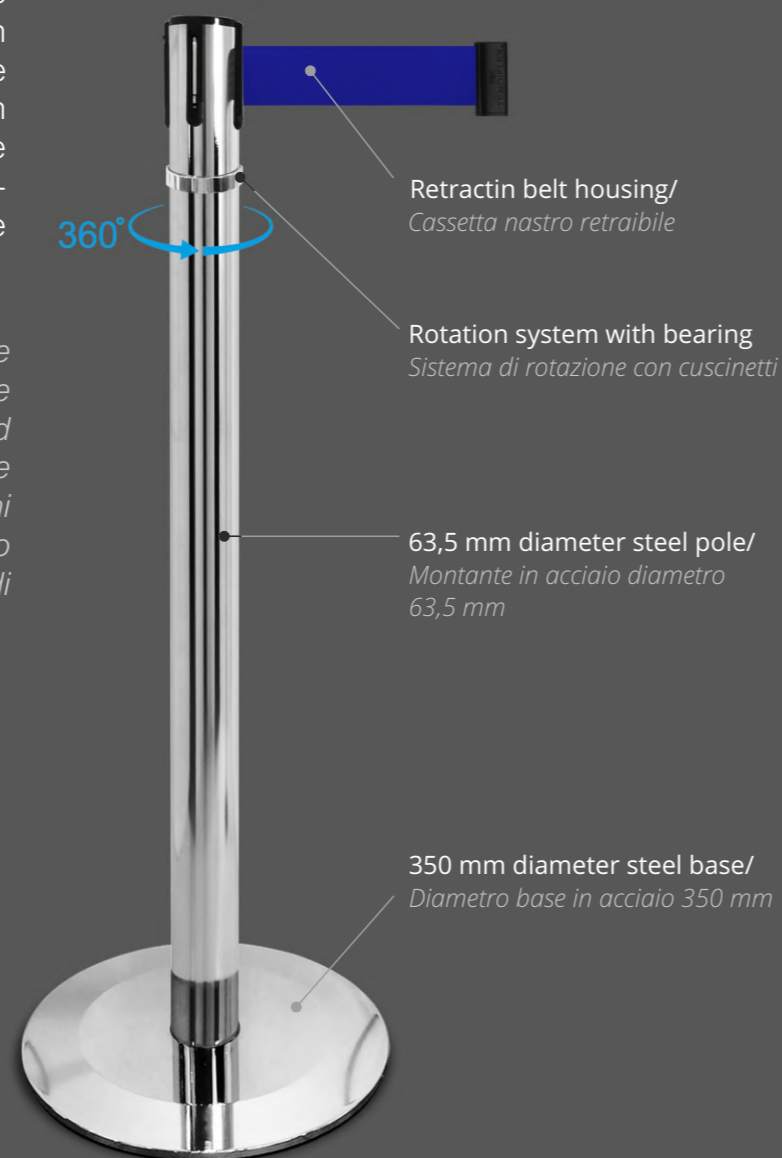

Height / *altezza*: 968 mm
Total stand weight 12 kg / *Peso totale colonnina* 12 kg

COLORS and FINISHES AVAILABLE / *COLORI e FINITURE DISPONIBILI*

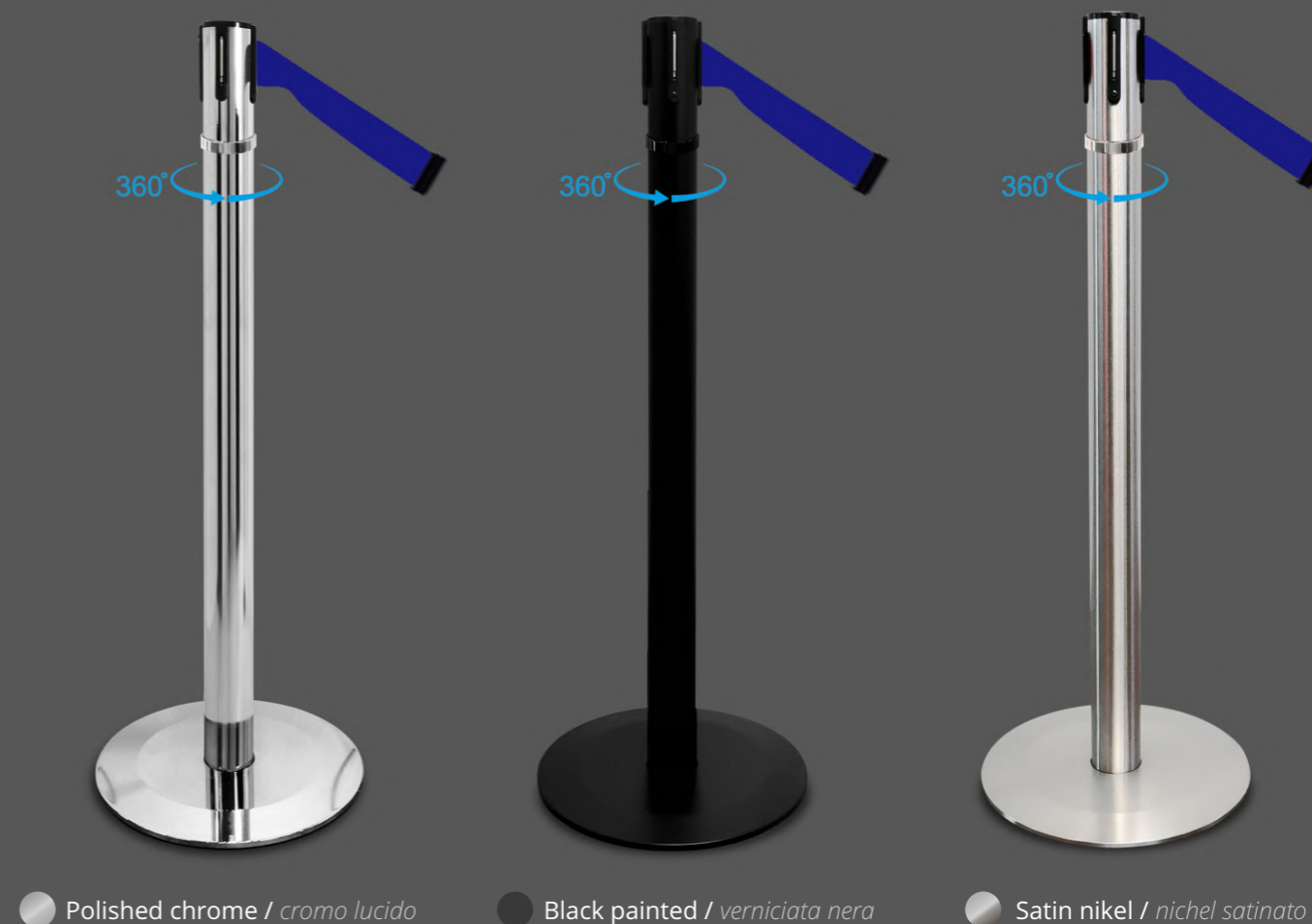

360°

360° POST HEAD ROTATION/ ROTAZIONE DI 360° DELLA TESTA DELLA COLONNINA

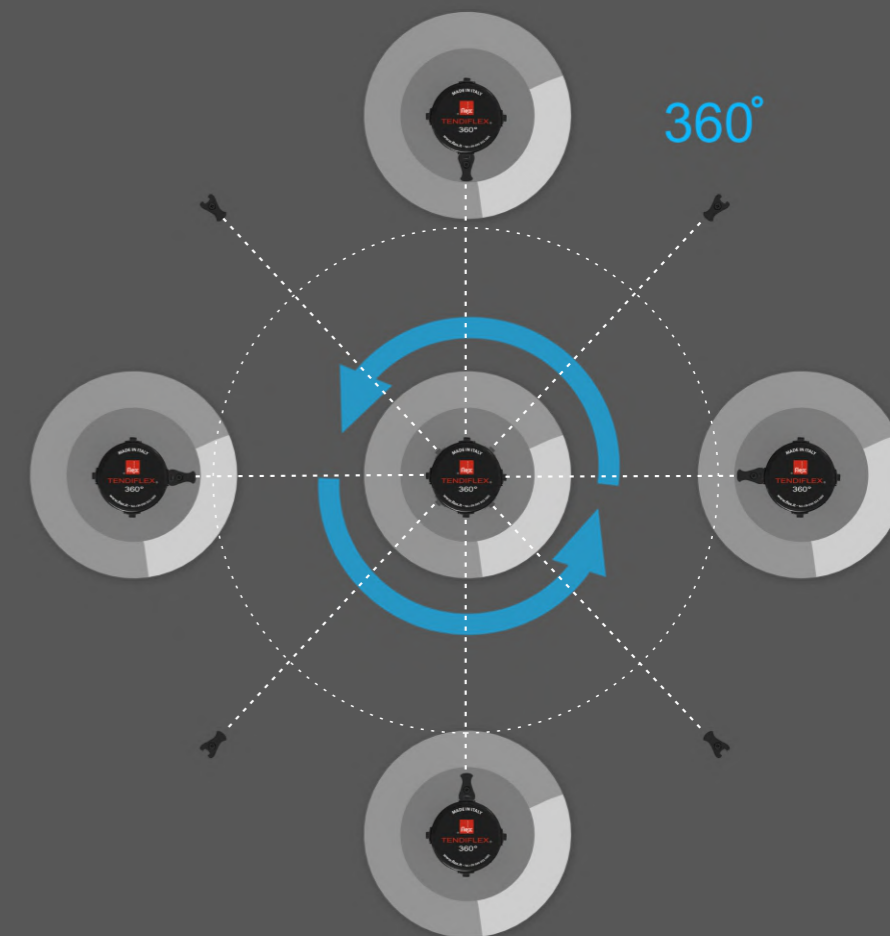
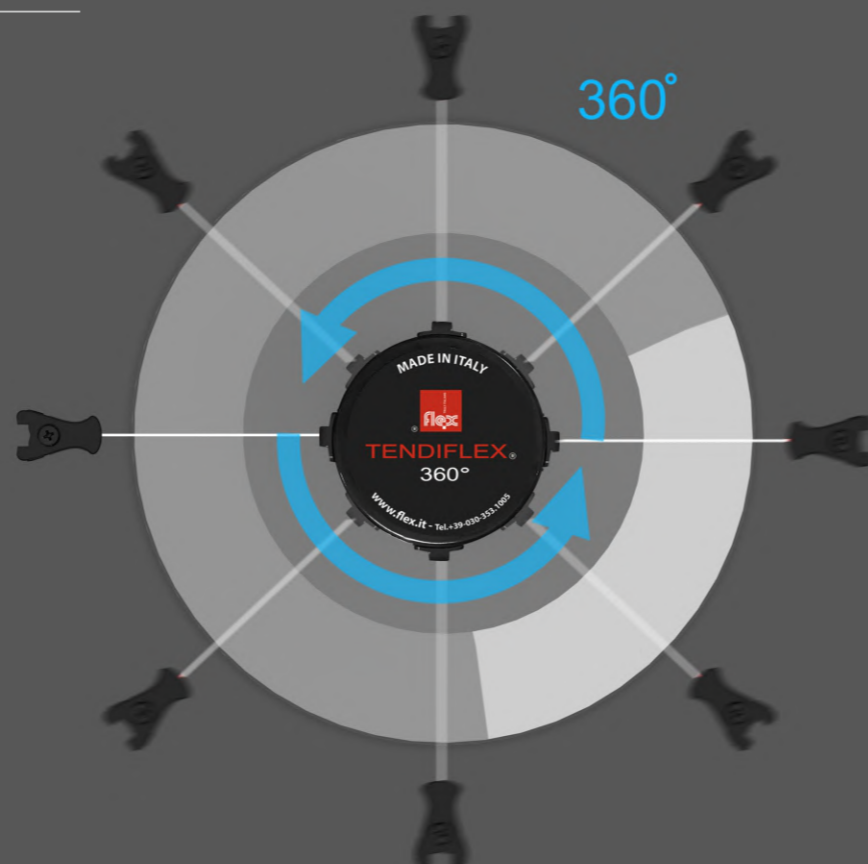

Our TENDIFLEX® 360° allows an even easier connection between posts thanks to the 360° rotation of the webbing head unit fixed on the upper part of the post. This technical solution enables the webbing to always be stretched and perfectly positioned, keeping a neat and tidy arrangement of the posts.

La nostra TENDIFLEX® 360° permette una connessione tra colonnine ancora più rapida grazie alla rotazione di 360° della parte superiore della colonnina, evitando così di sollevare e girare le colonnine per cambiarne la disposizione. Questa tecnica permette di avere il nastro sempre teso e in perfetta posizione, mantenendo la disposizione delle colonnine ordinata.

360° **360° POST HEAD ROTATION/**
ROTAZIONE DI 360° DELLA TESTA DELLA COLONNINA

Thanks to the 360° rotation of the upper part of the post, it is possible to quickly change the configuration of the path without having to move or turn the entire queueing post.

Grazie alla rotazione di 360° della parte superiore della colonnina è possibile modificare velocemente la configurazione del percorso senza dover spostare o girare l'intera colonnina.

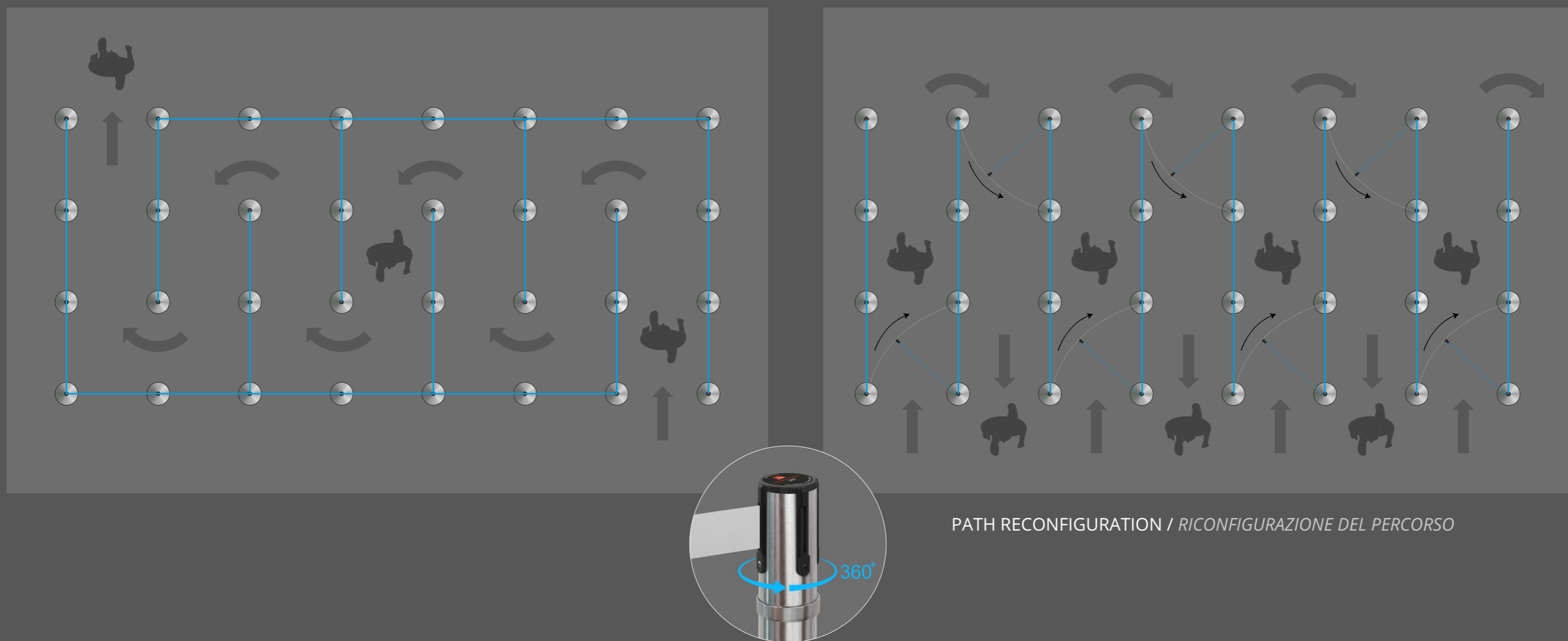

PATH RECONFIGURATION / RICONFIGURAZIONE DEL PERCORSO

! SOLVED PROBLEMS/ PROBLEMI RISOLTI

Having to lift and rotate 300/400 posts every time you need to reconfigure the path can be difficult and time consuming /

Dover sollevare e ruotare 300/400 colonnine ogni volta che necessiti di riconfigurare il percorso può essere difficoltoso e impegnativo.



NO NEED TO MOVE THE POST /
NESSUN BISOGNO DI SPOSTARE LA COLONNINA

Too often changing the queuing post configuration in an airport can result in an ugly visual effect due to the wrong belt hooking /

L'esigenza di modificare rapidamente la disposizione delle colonnine negli aeroporti comporta spesso un effetto visivo poco gradevole dovuto ad un aggancio errato del nastro.



CORRECT BELT HOOKING /
CORRETTO AGGANCIO DEL NASTRO

The incorrect re-hooking of the belt after changing the posts arrangement creates messy and confusing paths for the visitor /

Il riaggancio errato del nastro dopo una variazione della disposizione delle colonnine crea dei percorsi imprecisi e disordinati.

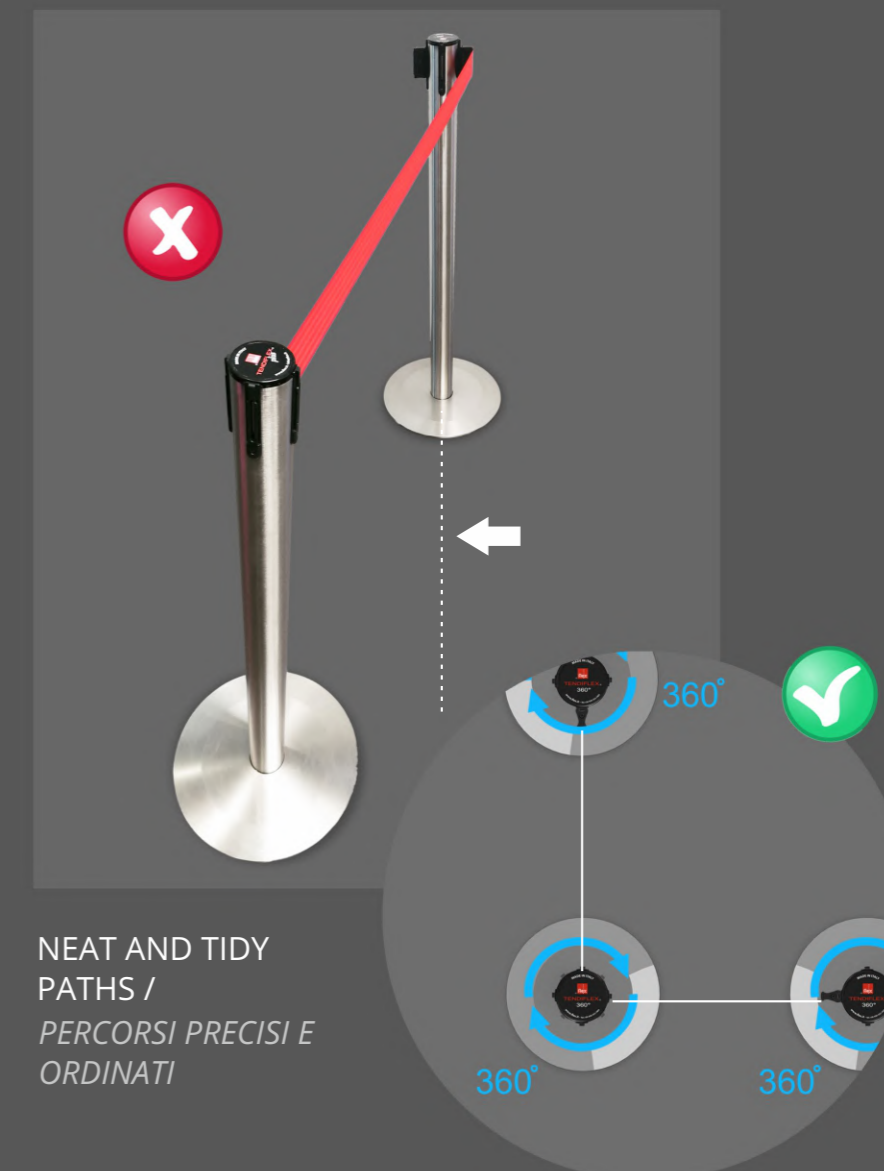

NEAT AND TIDY PATHS /
PERCORSI PRECISI E ORDINATI



ERGONOMIC AND MAGNETIC TAPE-END VERSION AVAILABLE/ DISPONIBILE CON AGGANCO ERGONOMICO E MAGNETICO

Our TENDIFLEX® 360° is available with 2 different types of tape-end:

Ergonomic: suggested in crowded environments such as airports and train stations.

Magnetic: allows a simple and fast “release” of the belt. Ideal in situations where safety is a priority.

La nostra TENDIFLEX® 360° è disponibile con 2 differenti tipologie di aggancio del nastro:

Ergonomico: consigliata in ambienti affollati come aeroporti e stazioni ferroviarie.

Magnetico: consente un “rilascio” semplice e veloce del nastro. Ideale in situazioni in cui la sicurezza è una priorità.



ERGONOMIC TAPE END/
AGGANCO ERGONOMICO



MAGNETIC TAPE END/
AGGANCO MAGNETICO

- A** Standard spline
Spline standard
- B** Standard ergonomic tape-end/
Aggancio ergonomico
- C** Spline slot + magnetic receiver/
Spline con fessura e magnete ricevitore
- D** Tape-end steel blade/
Aggancio con lama in acciaio



TOTAL BELT CUSTOMIZATION/ PERSONALIZZAZIONE TOTALE DEL NASTRO

The infinite resources of this product also allow to fully customize the expandable belt, thus creating a truly unique product. Company logos, event graphics, images, corporate colours, text, and directional wayfinding are just some possible uses.

Le infinite risorse di questo prodotto permettono di personalizzare il nastro estensibile con loghi e colori aziendali, fungendo così da importante strumento di marketing grazie alla sua totale customizzazione.

Fabric

Crease-proof polyester.

Glow Wire Test at a temperature of 650° accordance with IEC 60695-2-10 - IEC 60695-2-11

Tessuto

Poliestere antistazzonamento.

Glow Wire Test ad una temperatura di 650° secondo le norme IEC 60695-2-10 - IEC 60695-2-11

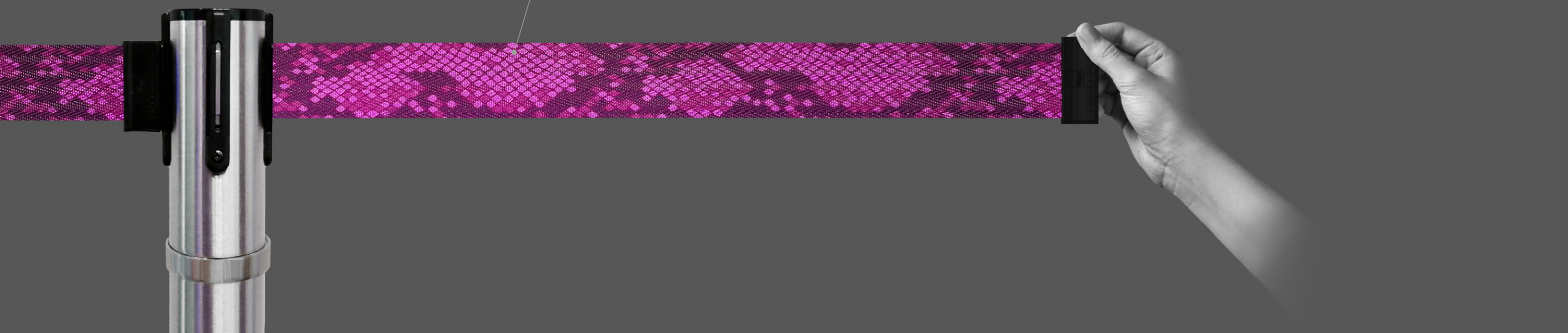



**WEBBING COLORS AVAILABLE/
COLORI NASTRI DISPONIBILI**







VERSION 230:
Height: 48 mm
Length: 2300 mm
Thickness: 0,80 +/-0,05 mm

VERSION 330:
Height: 48 mm
Length: 3300 mm
Thickness: 0,60 +/-0,05 mm

VERSIONE 230:
Altezza: 48 mm
Lunghezza: 2300 mm
Spessore: 0,80 +/-0,05 mm

VERSIONE 330:
Altezza: 48 mm
Lunghezza: 3300 mm
Spessore: 0,60 +/-0,05 mm

STANDARD COLORS

-  Red / rosso
-  Green / verde
-  Blue / blu
-  Burgundy / bordeaux
-  Neptune green / verde nettuno
-  Yellow / giallo
-  Brown / marrone
-  Black / nero
-  Grey / grigio

FLUO COLORS

-  Fluo pink / rosa fluo
-  Fluo green / verde fluo
-  Fluo yellow / giallo fluo
-  Fluo orange / arancio fluo
-  Custom color / Colore su richiesta

FLAT BASE TO FACILITATE THE MOVEMENT OF TROLLEYS AND SUITCASES/ BASE PIATTA PER FACILITARE LA MOVIMENTAZIONE DI CARRELLI E VALIGIE

The standard and magnetic bases of our TENDIFLEX® 360° have a very low thickness and a 7° diagonal chamfer, fundamental characteristics for a smooth pedestrian flow, especially in environments such as airports and stations.

Le basi standard e magnetiche della nostra TENDIFLEX® 360° hanno uno spessore molto ridotto e uno smusso diagonale di 7°, caratteristiche fondamentali per il corretto flusso pedonale, soprattutto in ambienti come aeroporti e stazioni.

Example of a common high thickness base/
Esempio di comune base ad alto spessore

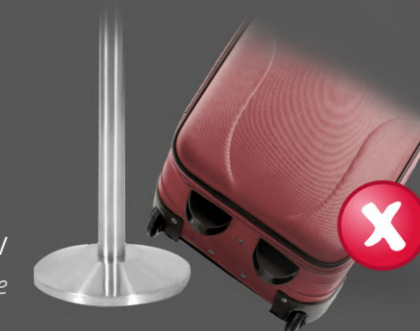

Flat base - solid steel 13,5 mm thick/
Base piatta - acciaio pieno spessore 13,5 mm





FLAT BASE - BASE VERSIONS/ BASE PIATTA - VERSIONI BASE

The 180mm and 280mm diameter magnetic base allow to increase the space dedicated to pedestrian flows thanks to its reduced diameter compared to the 350mm standard one.

Le magnetiche con diametro 180mm e 280mm consentono di aumentare gli spazi dedicati al flusso pedonale grazie ad un diametro ridotto rispetto alla base standard da 350mm.



Ø 350 mm

STANDARD BASE Ø 350 mm/
BASE STANDARD Ø 350 mm



Ø 350 mm

MAGNETIC BASE Ø 350 mm/
BASE MAGNETICA Ø 350 mm



Ø 280 mm

MAGNETIC BASE Ø 280 mm/
BASE MAGNETICA Ø 280 mm



Ø 180 mm

MAGNETIC BASE Ø 180 mm/
BASE MAGNETICA Ø 180 mm



Ø 150 mm

FIXED BASE Ø 150 mm/
BASE FISSA Ø 150 mm



STANDARD BASE ARE AVAILABLE/
DISPONIBILE CON BASE STANDARD

Ø 350 mm

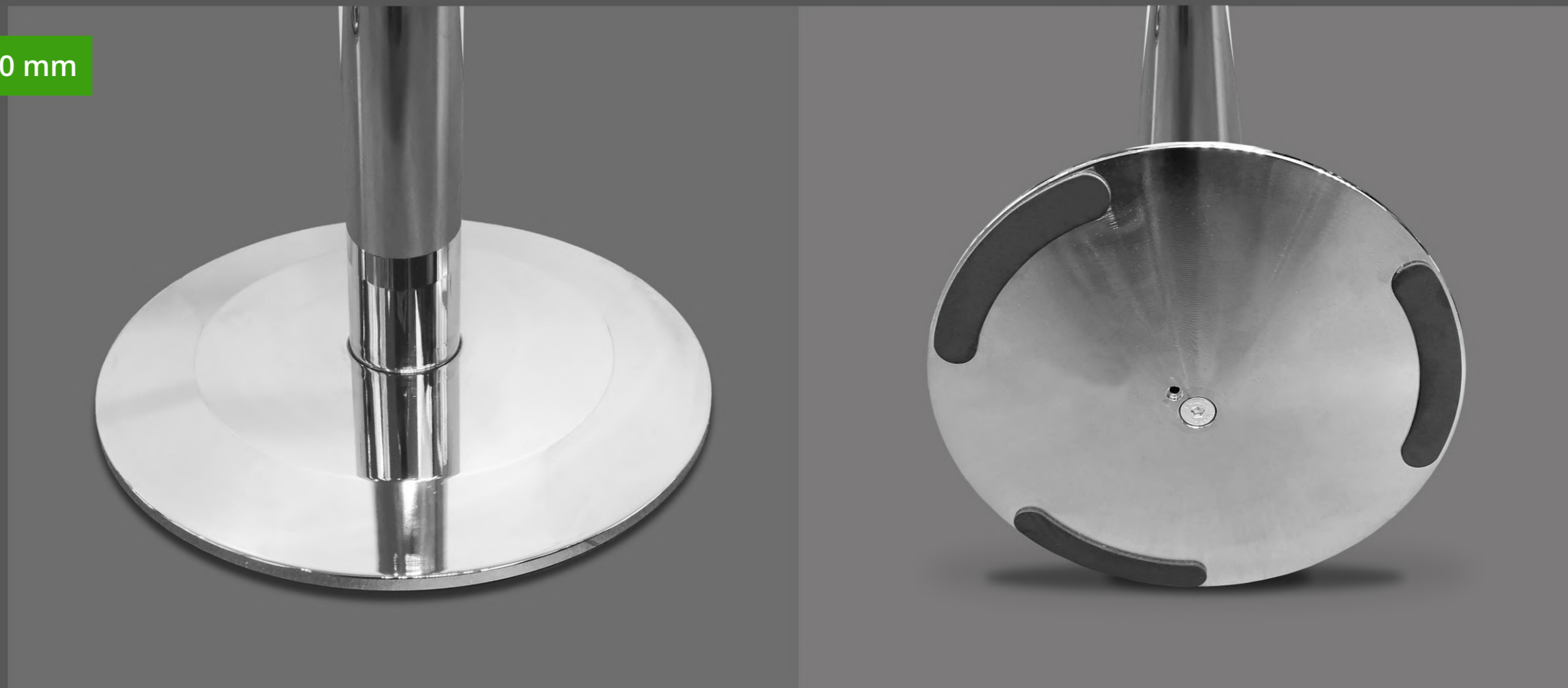

The standard base of TENDIFLEX® 360°, with a diameter of 350mm, makes the product stable thanks also to its weight of 8.7 kg. The steel base is very thin with a slight groove that makes it optimal in environments with high pedestrian flow.

La base standard della TENDIFLEX® 360°, dal diametro di 350mm, rende il prodotto stabile grazie anche al suo peso di 8,7 kg. La base, in acciaio, risulta molto sottile con una leggera scanalatura che la rende ottimale in ambienti ad alto flusso pedonale.



**MAGNETIC BASE ARE AVAILABLE/
DISPONIBILE CON BASE MAGNETICA**

Ø 350 mm

Ø 280 mm

Ø 180 mm

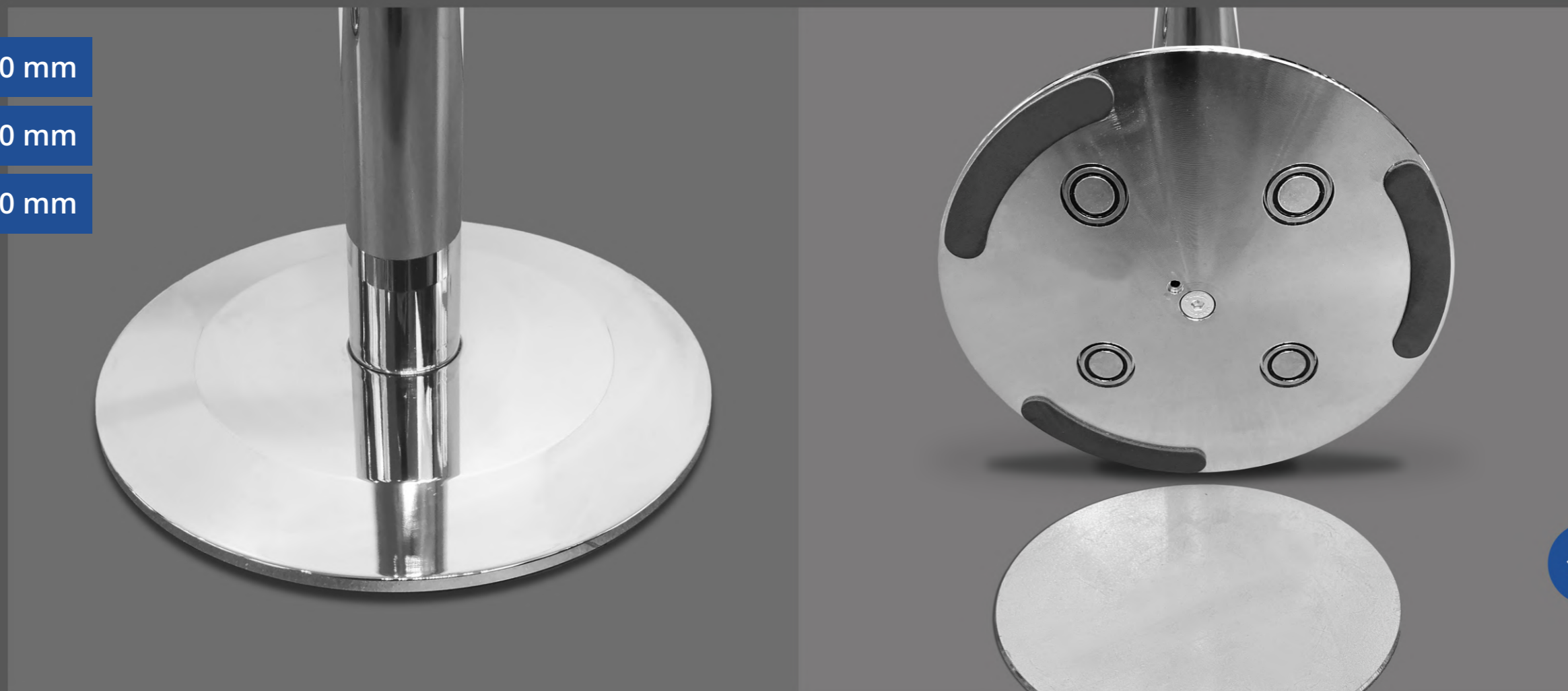

TENDIFLEX® 360° can be installed with magnetic fixing to the ground thanks to the galvanized disc positioned on the floor and the 4 magnets under the base of the post. The galvanized disks, upplied together with the posts, are fixed to the ground with 3M double-sided tape. They don't require any drilling operations.

TENDIFLEX® 360° può essere installata con fissaggio magnetico al suolo, grazie al disco zincato posizionato sul pavimento e ai 4 magneti sotto la base della colonnina. I dischi zincati, forniti insieme alla colonnina, vengono fissati al suolo con biadesivo 3M e non necessitano di operazioni di foratura.



**FIXED BASE ARE AVAILABLE/
DISPONIBILE CON BASE FISSA**

Ø 150 mm



Our special base of only 150 mm in diameter can be easily fixed to the ground by means of dowels. Ideal choice for a quick and hassle-free pedestrian path. This type of base is ideal in environments with high pedestrian traffic. In fact, thanks to its small diameter, it significantly reduces the overall dimensions.

La nostra base da soli 150 mm di diametro viene fissata al suolo tramite dei tasselli in maniera semplice. Scelta ideale per un percorso pedonale rapido e privo di intoppi. Questa tipologia di base è ideale in ambienti ad elevato traffico pedonale. Infatti, grazie al suo diametro ridotto, diminuisce notevolmente l'ingombro.



POSSIBILITY TO CONNECT THE TAPE ON 3 SIDES/ POSSIBILITÀ DI AGGANCIAMENTO DEL NASTRO SU 3 LATI

The possibility of hooking the tape on 3 sides allows to gain freedom and dynamism in the configuration of optimized pedestrian paths.

La possibilità di agganciare il nastro su 3 lati consente di ottenere libertà e dinamismo nella configurazione di percorsi pedonali ottimizzati.

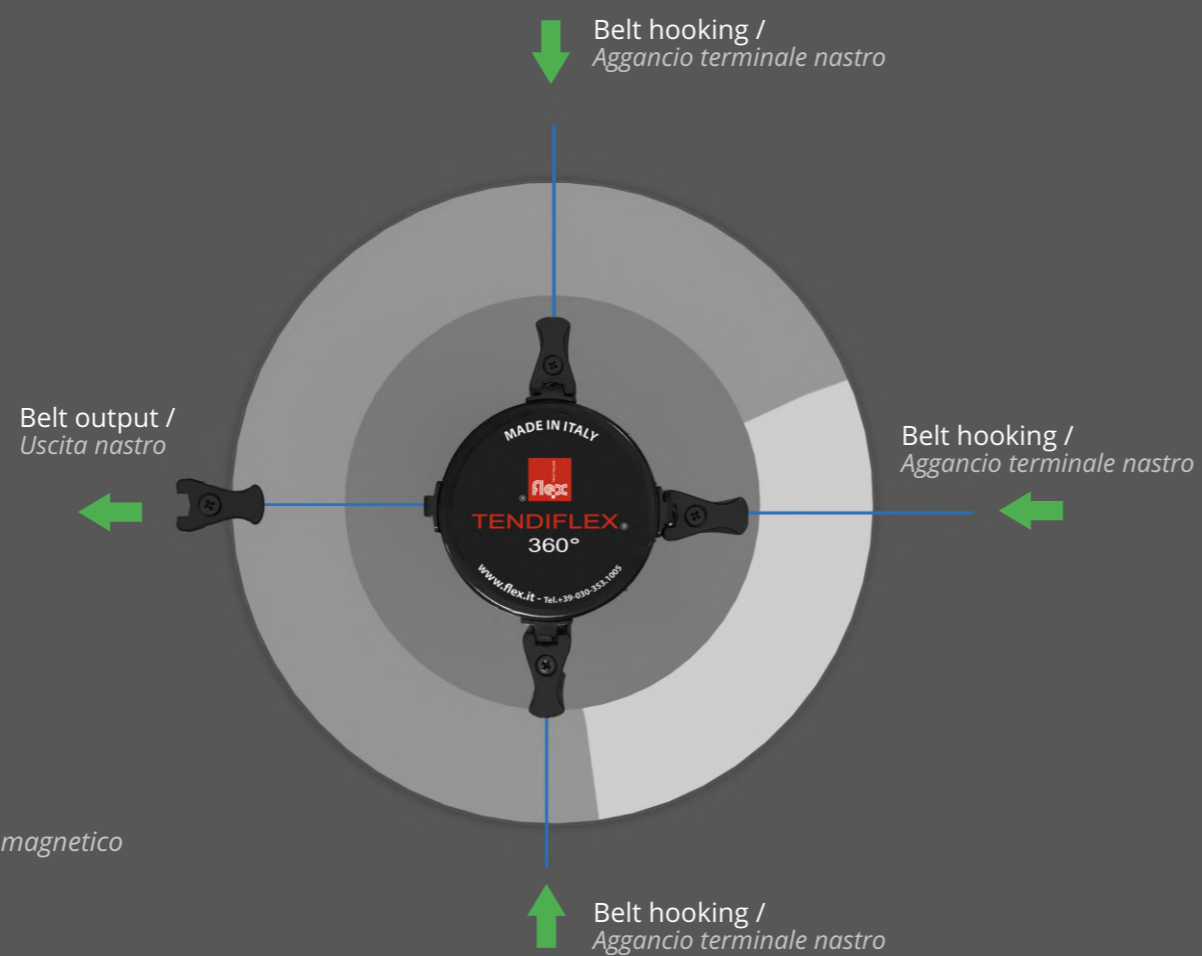

- A** Retracting belt housing /
Cassetta nastro
- B** Retracting belt /
Nastro retraibile
- C** Ergonomic or magnetic tape-end /
Blocchetto aggancio/sgancio ergonomico o magnetico
- D** Spline / Spline

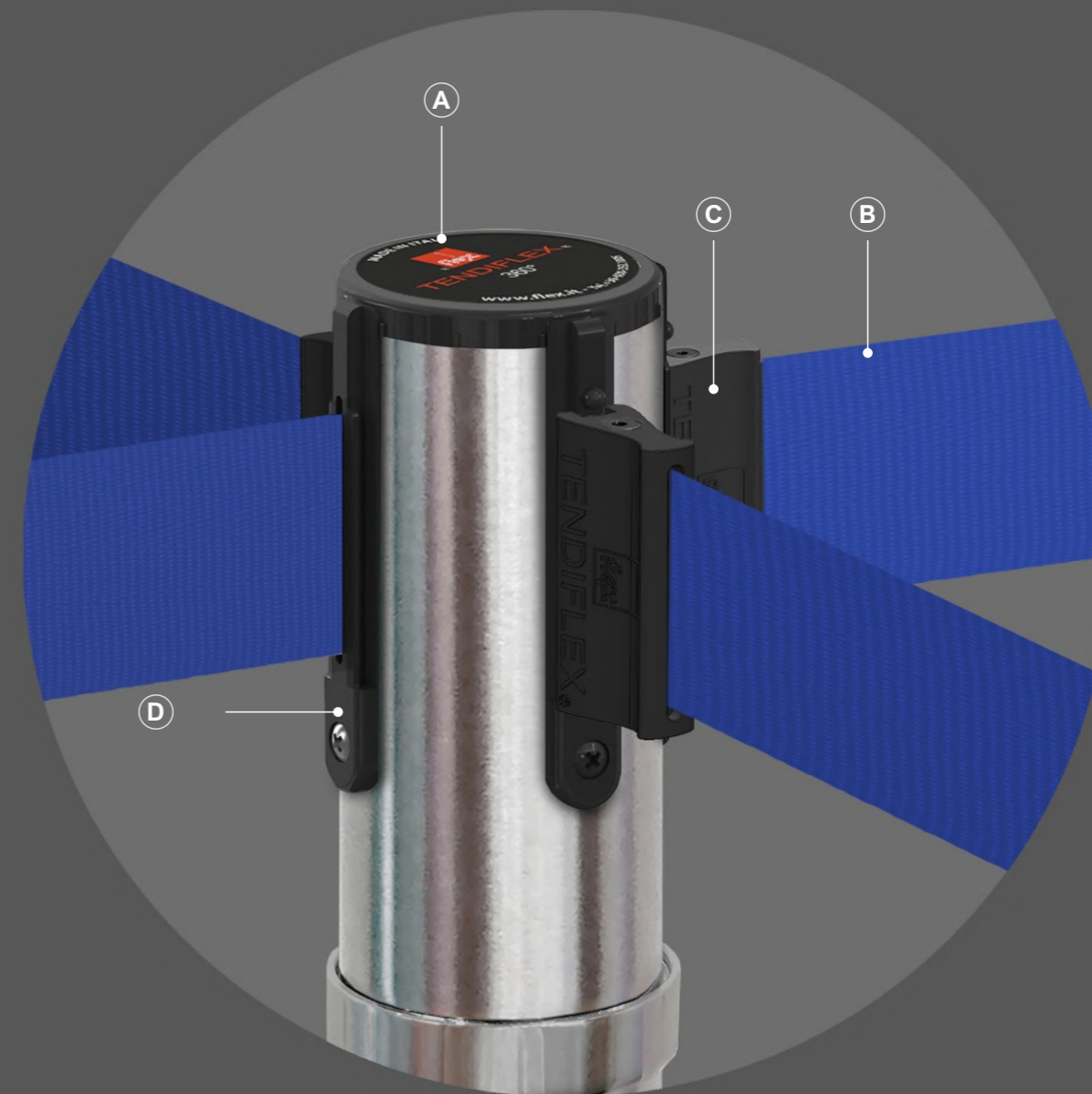

ACC

**TENDIFLEX® SPORT SIGN HOLDER/
PORTA CARTELLO PER TENDIFLEX® SPORT**

The TENDIFLEX® SPORT post can come with additional accessories, such as the sign holder with shockproof transparent methacrylate panel, which allows a quick message replacement by simply changing the communication inside.

La colonnina TENDIFLEX® SPORT può essere dotata di accessori aggiuntivi, come il porta cartello con pannello in metacrilato trasparente antiurto, che consente un rapido cambio del messaggio semplicemente cambiando la comunicazione all'interno.



Double-sided methacrylate
Sign holder/
*Pannello porta cartello bifacciale
In metacrilato*

Brass frame.
Finishing: painted black or polished chrome
*Cornice in ottone.
Finitura: verniciato nero o cromo lucido*

High-strength polyamide (pa) cone/
Cono in poliammide (pa) ad alta resistenza



Quick and easy change of message/
Semplice e rapido cambio del messaggio

Examples of use / *Esempi di utilizzo*



Examples of use / *Esempi di utilizzo*



Examples of use / *Esempi di utilizzo*



Examples of use / *Esempi di utilizzo*



Since 1990 we have been changing the way people experience public spaces: faster pedestrian flows, clear information, impactful communication.

We bring light, color and beauty to all environments, making them better organized and more pleasant.

Get in touch with us to find out more!

Dal 1990 cambiamo il modo in cui le persone vivono i luoghi pubblici: flussi pedonali più veloci, informazioni chiare, comunicazione d'impatto.

Portiamo luce, colore e bellezza in tutti gli ambienti, rendendoli meglio organizzati e più piacevoli.

Contattaci per saperne di più!





Flex s.r.l
via Gaetano Bargnani, 11
25135 Brescia (BS), Italy
info@flex.it
tendiflex.it
flex.it

