



# SIGN LINE

## TECHNICAL BOOK

---

DESIGN & SOLUTIONS



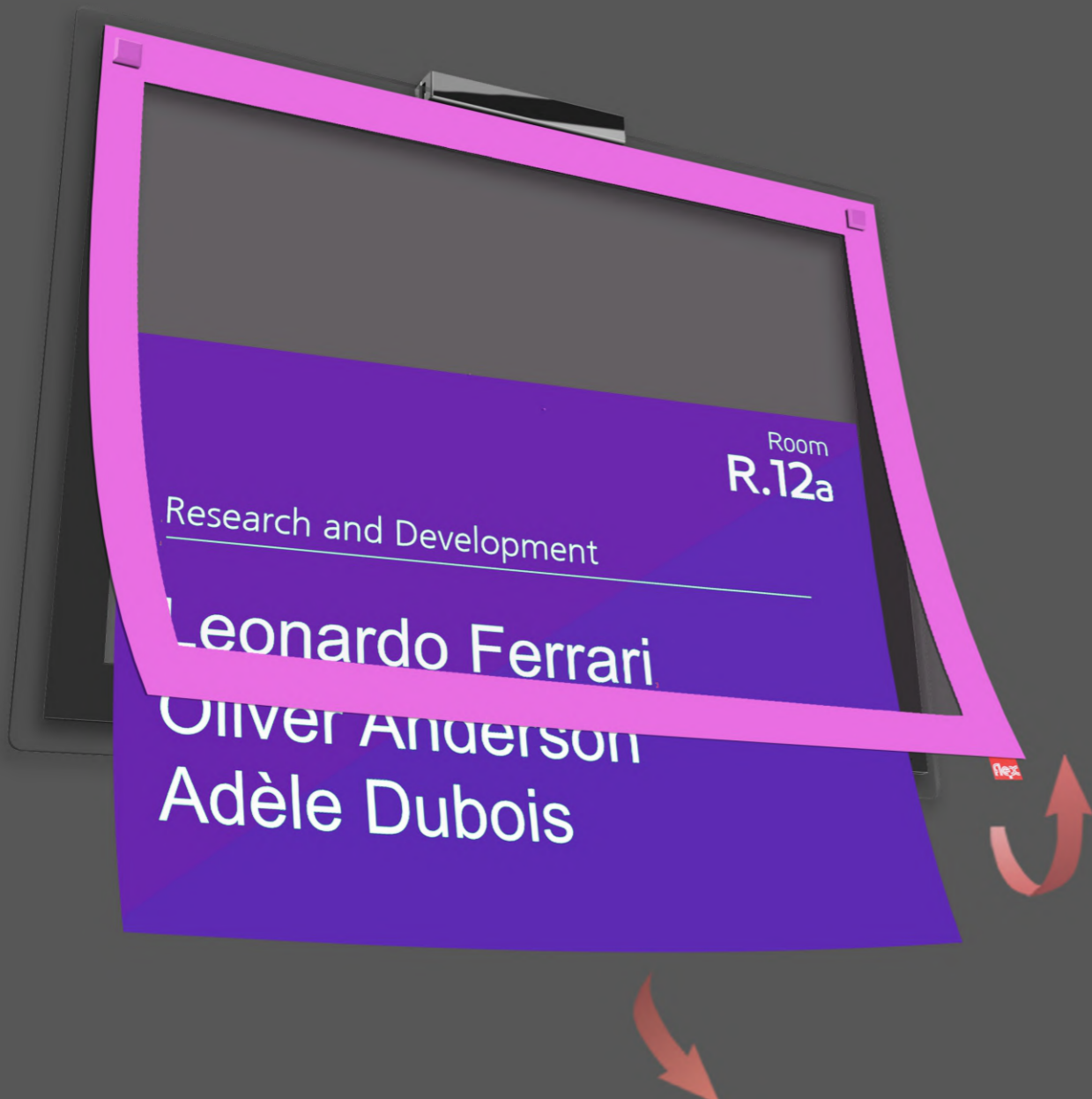

## PRODUCT BEST FEATURES/ PARTICOLARITÀ DEL PRODOTTO

- 
**ELEGANT AND REFINED DESIGN/**  
*DESIGN ELEGANTE E RAFFINATO*

---

- 
**QUICK AND EASY MESSAGE REPLACEMENT/**  
*SEMPLICE E RAPIDO CAMBIO DEL MESSAGGIO*

---

- 
**VARIOUS SIZES AVAILABLE/**  
*VARI FORMATI DISPONIBILI*

---

- 
**INSTALLATION FLEXIBILITY (WALL-MOUNTET, GLASS-MOUNTET, FLAG, HANGING ON THE CEILING, ON CABLES)/**  
*VERSATILITÀ D'INSTALLAZIONE (A PARETE, A VETRO, A BANDIERA, SOSPESO A SOFFITTO, SU CAVI)*

---

- 
**POSSIBILITY TO CUSTOMIZE THE PRODUCT/**  
*POSSIBILITÀ DI PERSONALIZZARE IL PRODOTTO*



## QUICK AND EASY MESSAGE REPLACEMENT/ SEMPLICE E RAPIDO CAMBIO DEL MESSAGGIO

By lifting the magnetic frame, the SIGN LINE system allows for a quick replacement of the poster: open the frame, remove the old message and replace it with a new one.

*Sollevando la cornice magnetica, il sistema SIGN LINE consente una rapida sostituzione del poster: apri la cornice, rimuovi il vecchio messaggio e sostituisilo con quello nuovo.*

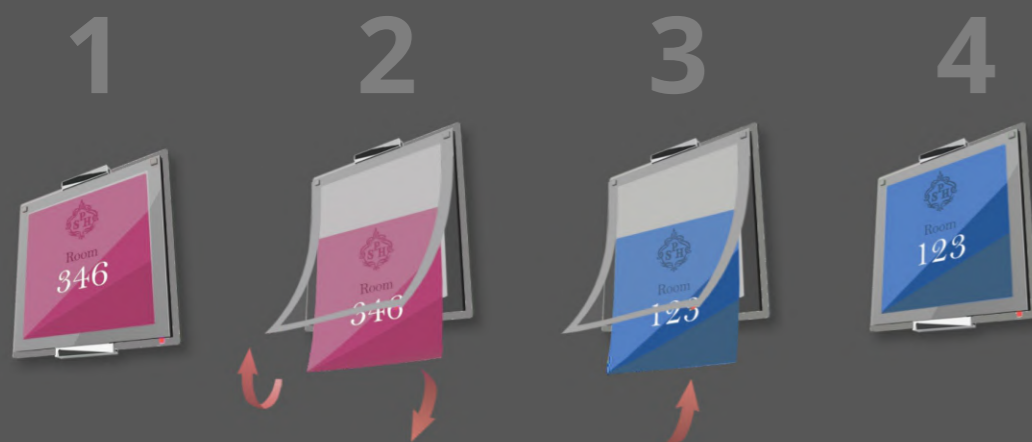

**OPEN - REMOVE - INSERT**





## ELEGANT AND REFINED DESIGN/ DESIGN ELEGANTE E RAFFINATO

The SIGN LINE is a message holder system characterized by the revolutionary new magnetic system for changing the message. It is extremely easy to handle and it dispose of several formats so as to adapt to any environment and to meet any requirement.

*La linea SIGN LINE è un sistema porta messaggio caratterizzato dalla semplicità e maneggevolezza del cambio messaggio con sistema magnetico, dalla bifaccialità e dalla moltitudine dei formati per adeguarsi a ogni ambiente e configurarsi in modi diversi.*



ABS cover/

*Cover in ABS*

Closing panel clip/

*Clip di chiusura pannello*

Message protection in  
1 mm thick transparent polycarbonate/

*Protezione messaggio in  
policarbonato trasparente spessore 1 mm*

Gray printed mount/

*Cornice serigrafata grigia*

Methacrylate panel  
transparent thickness 5 mm/

*Pannello in metacrilato  
trasparente spessore 5 mm*

FLEX label 1x1 cm/

*Etichetta FLEX dimensione 1x1 cm*



The purity of design of the matching fixing block to the transparency of the surfaces, make SIGN LINE one signage solution that enhances any environment and enhances any message.

*La purezza di design del blocchetto di fissaggio, abbinato alla trasparenza delle superfici, fanno di SIGN LINE una soluzione segnaletica che valorizza ogni ambiente ed esalta qualunque messaggio.*





**TOTALLY CUSTOMIZABLE PRODUCT/  
TOTALE PERSONALIZZAZIONE DEL PRODOTTO**

The SIGN LINE is a totally customizable product, in fact based on the customer's request, it is possible to customize the external frame by coordinating it with your company colors. You can also insert textures, images and more. This plus allows you to further emphasize the internal message of the product.

*La linea SIGN LINE è un prodotto totalmente personalizzabile, infatti in base alla richiesta del cliente, è possibile personalizzare la cornice esterna coordinandola ai propri colori aziendali. È anche possibile inserire texture, immagini e molto altro. Questo plus consente di enfatizzare ancor più il messaggio interno del prodotto.*

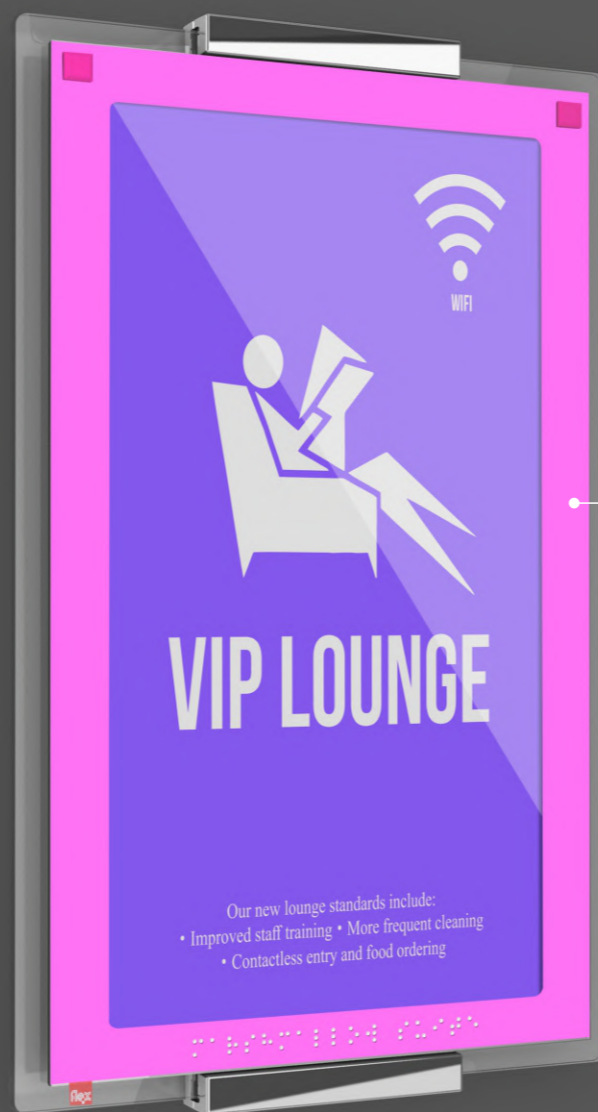

Digital print colored frame/  
Cornice colorata in stampa digitale

The frame can be totally customized on customer request, with colors, textures, logos, images, texts, etc.

*La cornice può essere totalmente personalizzata su richiesta del cliente, con colori, texture, loghi, immagini, testi etc.*



Use of Braille code for visually impaired and blind people.

*Utilizzo del codice BRAILLE per le persone ipovedenti e non vedenti.*





**TOTALLY CUSTOMIZABLE PRODUCT/  
TOTALE PERSONALIZZAZIONE DEL PRODOTTO**

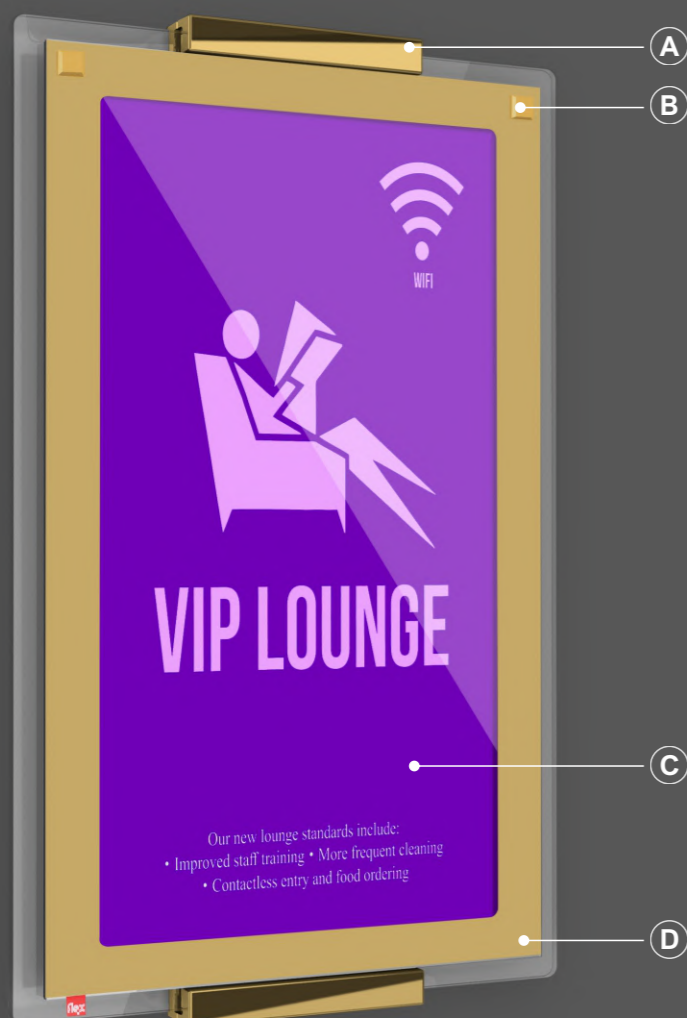

Model / Modello *Gold*

**EXAMPLE: COLOR MATCHING/  
ESEMPIO: ABBINAMENTO COLORI**



- A** ABS cover - color POLISHED GOLD or SATIN GOLD/  
Cover in ABS - colore ORO LUCIDO o ORO SATINATO
- B** Closing panel clip - color POLISHED GOLD/  
Clip di chiusura pannello - ORO LUCIDO
- C** 200 gr Paper Poster/  
Poster di carta - 200 gr
- D** Digital printed mount - color GOLD/  
Cornice stampata in digitale - colore ORO





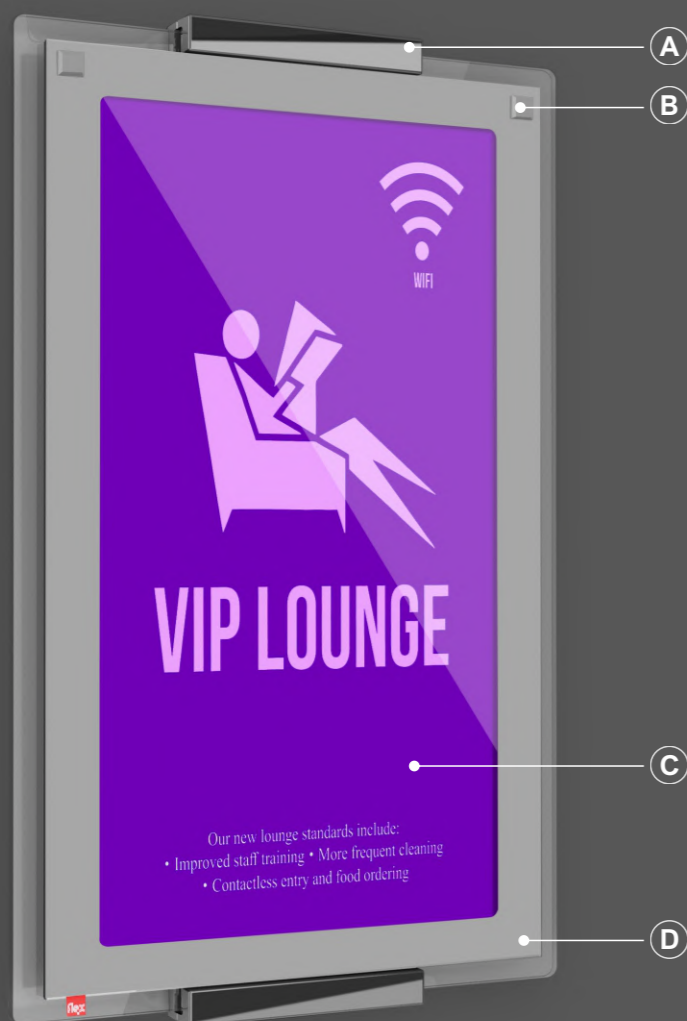

**TOTALLY CUSTOMIZABLE PRODUCT/**  
*TOTALE PERSONALIZZAZIONE DEL PRODOTTO*



Model / Modello *Silver*

**EXAMPLE: COLOR MATCHING/**  
*ESEMPIO: ABBINAMENTO COLORI*



- A** ABS cover - color POLISHED CHROME or SATIN NICKEL/  
*Cover in ABS - colore CROMO LUCIDO o NICHEL SATINATO* 
- B** Closing panel clip - color GREY/  
*Clip di chiusura pannello - colore GRIGIO* 
- C** 200 gr Paper Poster/  
*Poster di carta - 200 gr*
- D** Gray printed mount - color SILVER/  
*Cornice serigrafata grigia - colore ARGENTO* 





**TOTALLY CUSTOMIZABLE PRODUCT/**  
*TOTALE PERSONALIZZAZIONE DEL PRODOTTO*

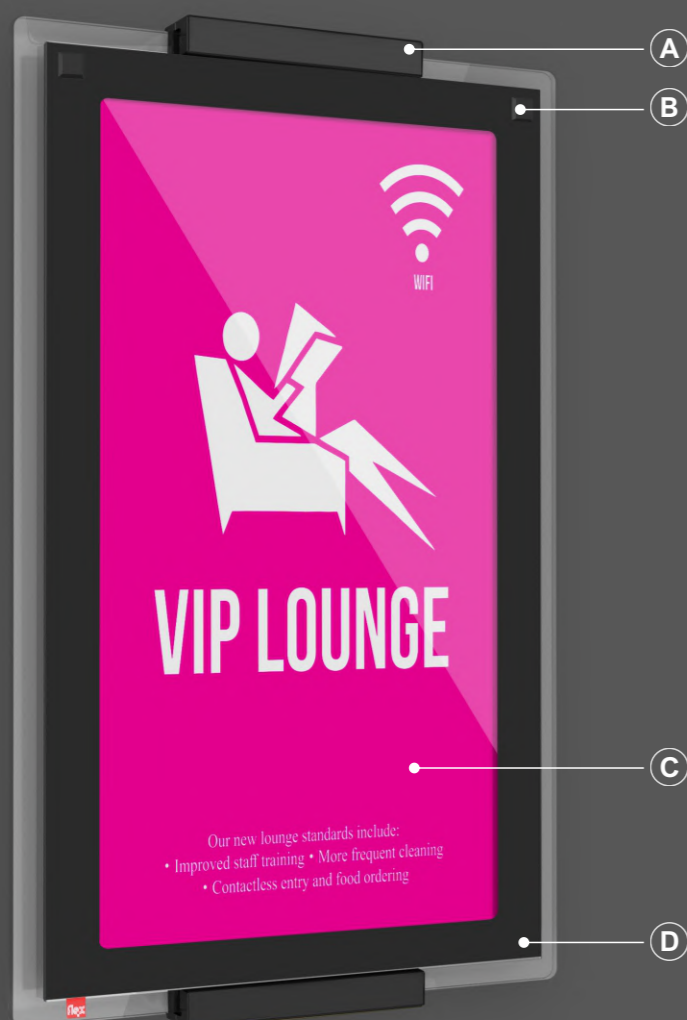

**EXAMPLE: COLOR MATCHING/**  
*ESEMPIO: ABBINAMENTO COLORI*

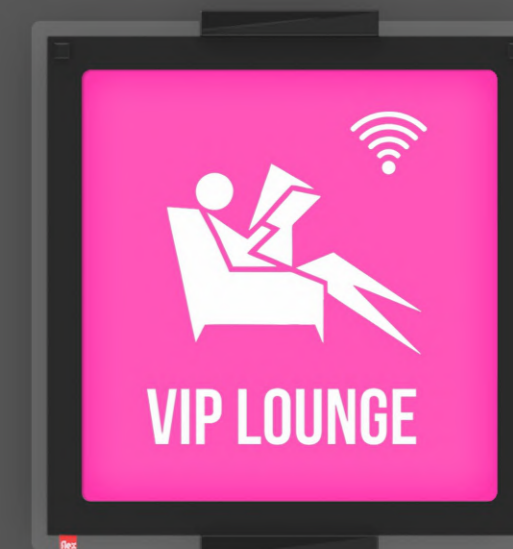
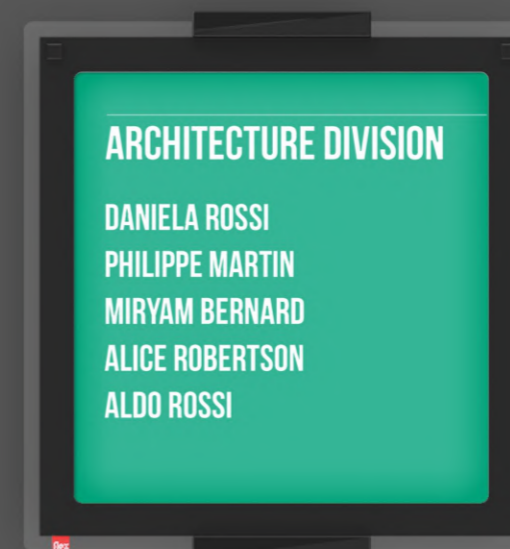

- A** ABS cover - color BLACK/  
*Cover in ABS - colore NERO*
- B** Closing panel clip - color BLACK/  
*Clip di chiusura pannello - colore NERO*
- C** 200 gr Paper Poster/  
*Poster di carta - 200 gr*
- D** Digital printed mount - color BLACK/  
*Cornice stampata in digitale - colore NERO*

Model / Modello *Black*







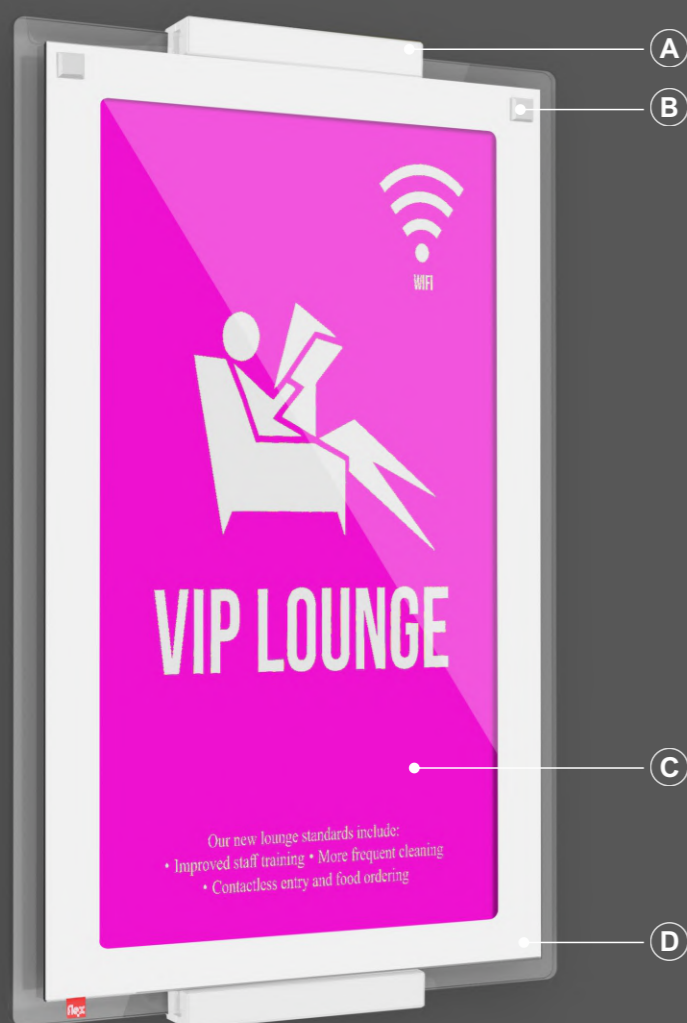

**TOTALLY CUSTOMIZABLE PRODUCT/**  
*TOTALE PERSONALIZZAZIONE DEL PRODOTTO*



Model / Modello *White*

**EXAMPLE: COLOR MATCHING/**  
*ESEMPIO: ABBINAMENTO COLORI*



- A** ABS cover - color WHITE/  
Cover in ABS - colore BIANCO 
- B** Closing panel clip - color WHITE/  
Clip di chiusura pannello - colore BIANCO 
- C** 200 gr Paper Poster/  
Poster di carta - 200 gr
- D** Digital printed mount - color WHITE/  
Cornice stampata in digitale - colore BIANCO 





**TOTALLY CUSTOMIZABLE PRODUCT/**  
*TOTALE PERSONALIZZAZIONE DEL PRODOTTO*

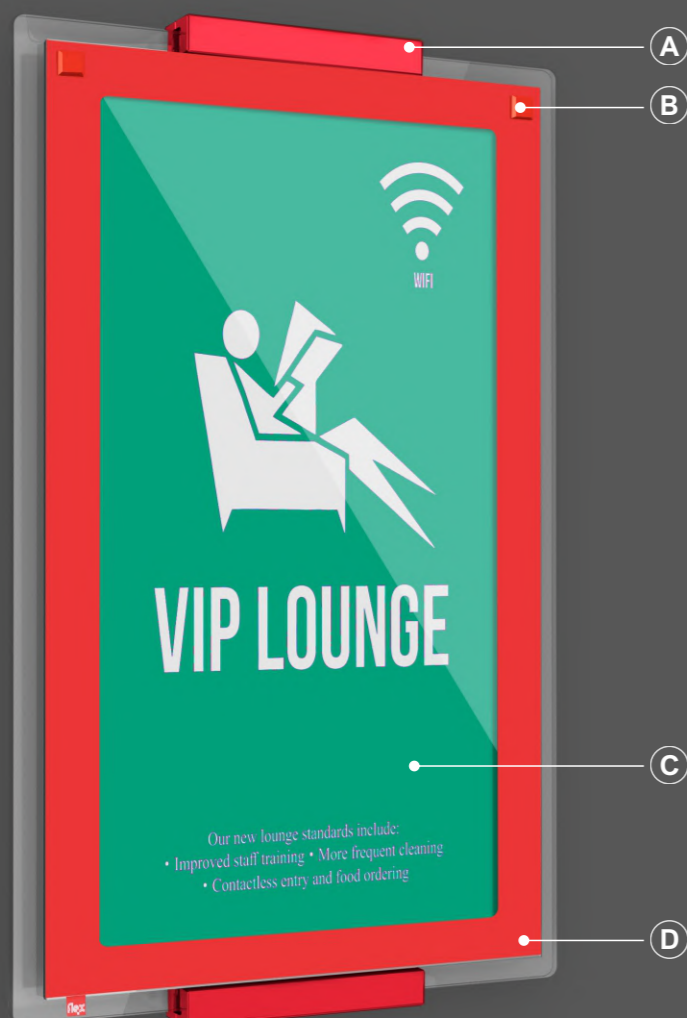

Model / Modello *Red*

**EXAMPLE: COLOR MATCHING/**  
*ESEMPIO: ABBINAMENTO COLORI*

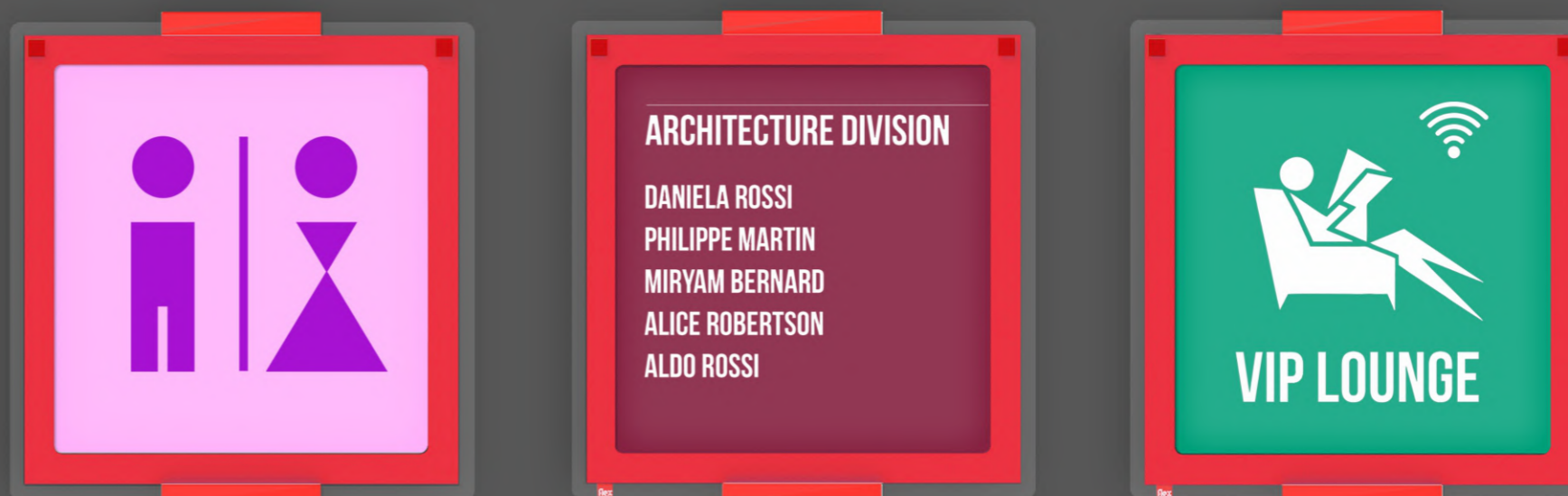

- A** ABS cover - color RED/  
*Cover in ABS - colore ROSSO*
- B** Closing panel clip - color RED/  
*Clip di chiusura pannello - colore ROSSO*
- C** 200 gr Paper Poster/  
*Poster di carta - 200 gr*
- D** Digital printed mount - color RED/  
*Cornice stampata in digitale - colore ROSSO*





**TOTALLY CUSTOMIZABLE PRODUCT/**  
*TOTALE PERSONALIZZAZIONE DEL PRODOTTO*

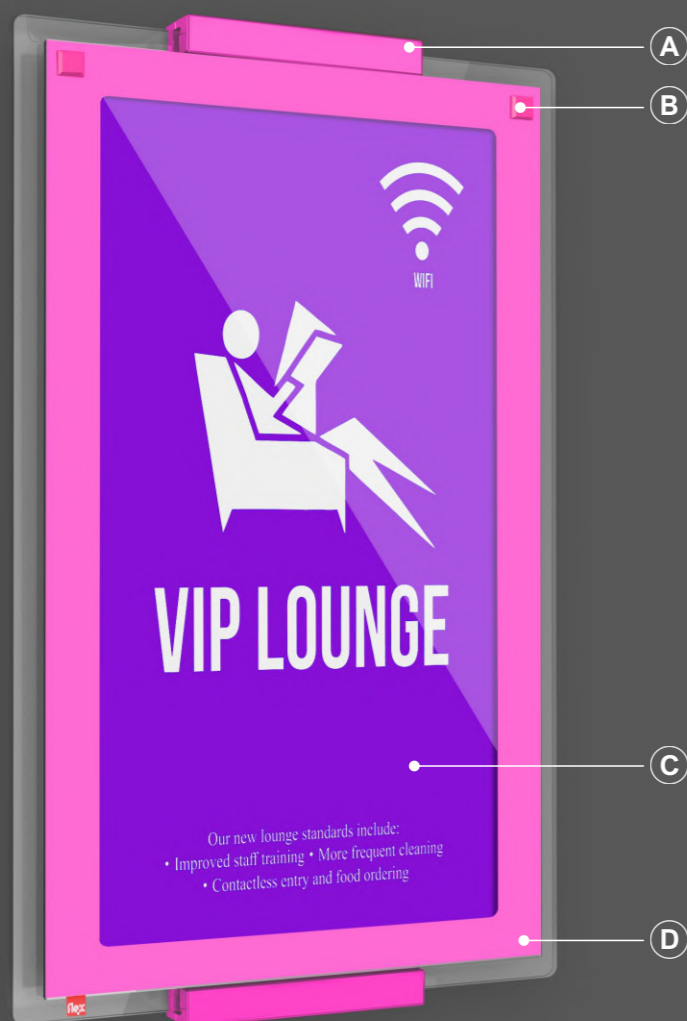

Model / Modello *Pink*

**EXAMPLE: COLOR MATCHING/**  
*ESEMPIO: ABBINAMENTO COLORI*



- A** ABS cover - color PINK/  
*Cover in ABS - colore ROSA*
- B** Closing panel clip - color PINK/  
*Clip di chiusura pannello - colore ROSA*
- C** 200 gr Paper Poster/  
*Poster di carta - 200 gr*
- D** Digital printed mount - color PINK/  
*Cornice stampata in digitale - colore ROSA*





**TOTALLY CUSTOMIZABLE PRODUCT/**  
*TOTALE PERSONALIZZAZIONE DEL PRODOTTO*

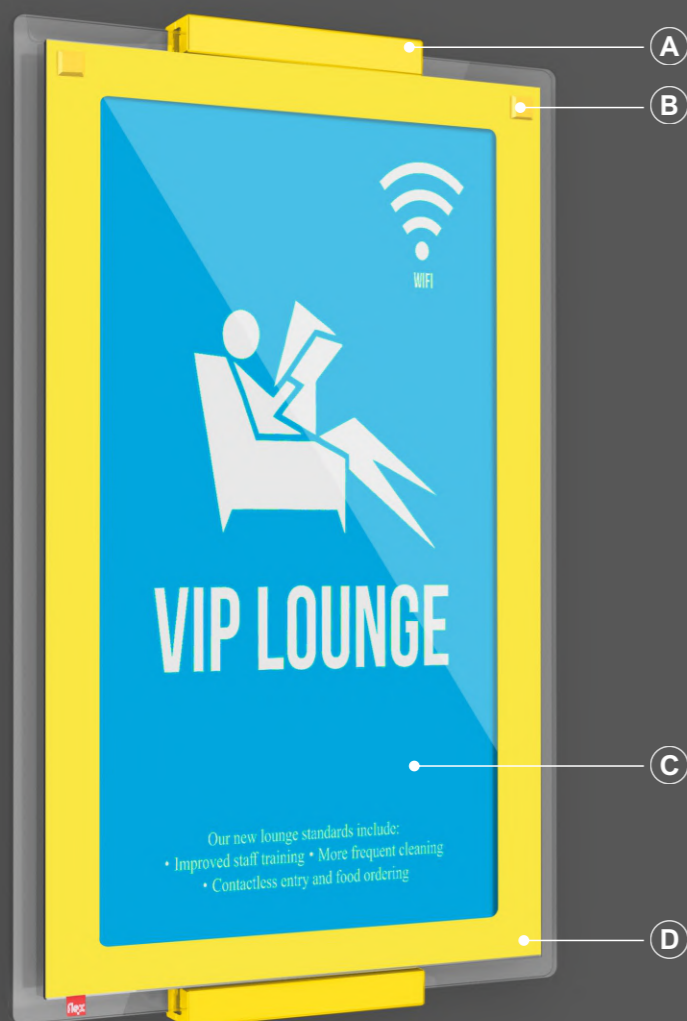

Model / Modello *Yellow*

**EXAMPLE: COLOR MATCHING/**  
*ESEMPIO: ABBINAMENTO COLORI*



- A** ABS cover - color YELLOW/  
*Cover in ABS - colore GIALLO*
- B** Closing panel clip - color YELLOW/  
*Clip di chiusura pannello - colore GIALLO*
- C** 200 gr Paper Poster/  
*Poster di carta - 200 gr*
- D** Digital printed mount - color YELLOW/  
*Cornice stampata in digitale - colore GIALLO*





**TOTALLY CUSTOMIZABLE PRODUCT/**  
*TOTALE PERSONALIZZAZIONE DEL PRODOTTO*

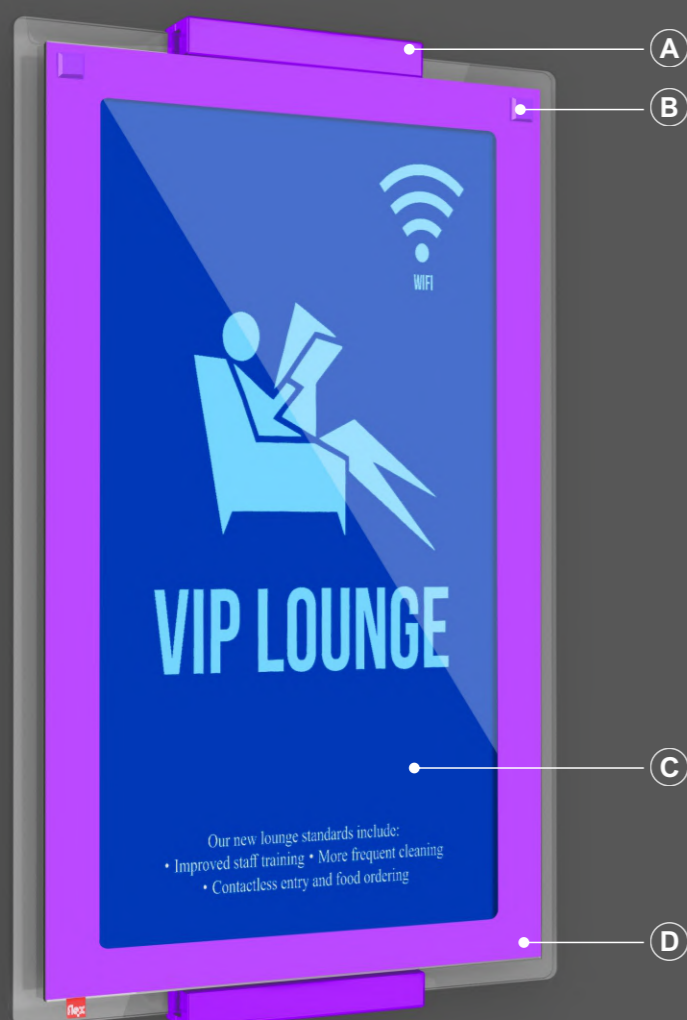

Model / Modello *Purple*

**EXAMPLE: COLOR MATCHING/**  
*ESEMPIO: ABBINAMENTO COLORI*



- A** ABS cover - color PURPLE/  
*Cover in ABS - colore VIOLA*
- B** Closing panel clip - color PURPLE/  
*Clip di chiusura pannello - colore VIOLA*
- C** 200 gr Paper Poster/  
*Poster di carta - 200 gr*
- D** Digital printed mount - color PURPLE/  
*Cornice stampata in digitale - colore VIOLA*





**TOTALLY CUSTOMIZABLE PRODUCT/**  
*TOTALE PERSONALIZZAZIONE DEL PRODOTTO*



**EXAMPLE: COLOR MATCHING/**  
*ESEMPIO: ABBINAMENTO COLORI*

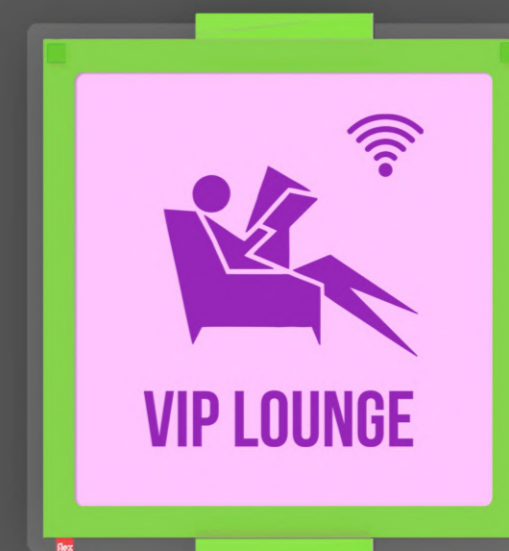

- A** ABS cover - color GREEN/  
*Cover in ABS - colore VERDE*
- B** Closing panel clip - color GREEN/  
*Clip di chiusura pannello - colore VERDE*
- C** 200 gr Paper Poster/  
*Poster di carta - 200 gr*
- D** Digital printed mount - color GREEN/  
*Cornice stampata in digitale - colore VERDE*

Model / Modello *Green*





**TOTALLY CUSTOMIZABLE PRODUCT/**  
*TOTALE PERSONALIZZAZIONE DEL PRODOTTO*

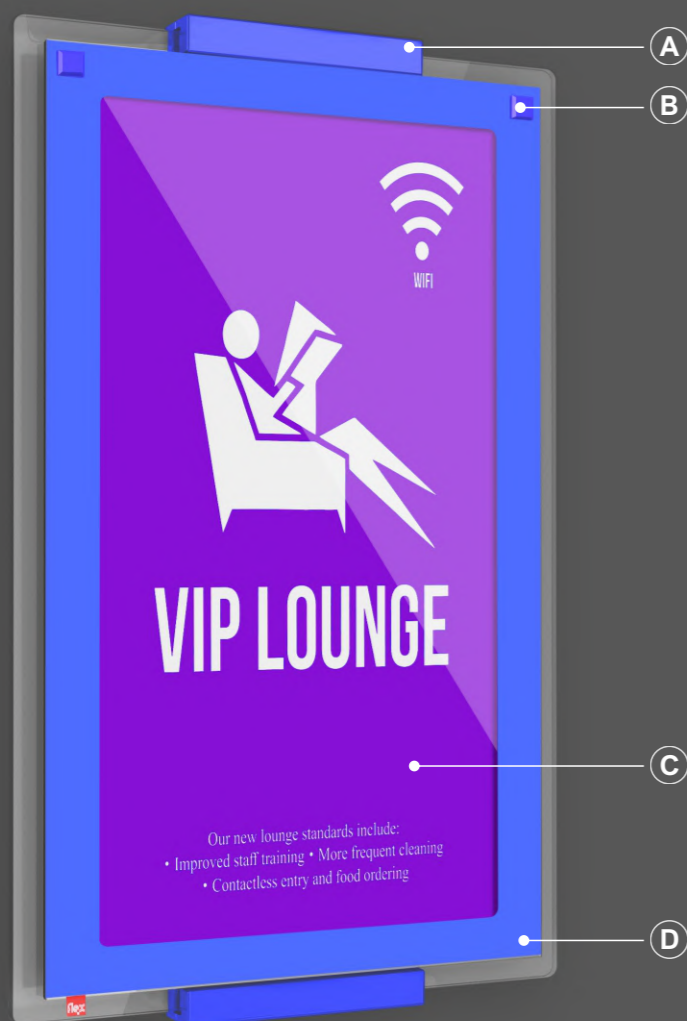

**EXAMPLE: COLOR MATCHING/**  
*ESEMPIO: ABBINAMENTO COLORI*



- A** ABS cover - color BLUE/  
*Cover in ABS - colore BLU*
- B** Closing panel clip - color BLUE/  
*Clip di chiusura pannello - colore BLU*
- C** 200 gr Paper Poster/  
*Poster di carta - 200 gr*
- D** Digital printed mount - color BLUE/  
*Cornice stampata in digitale - colore BLU*

Model / Modello *Blue*





**TOTALLY CUSTOMIZABLE PRODUCT/**  
*TOTALE PERSONALIZZAZIONE DEL PRODOTTO*



**EXAMPLE: COLOR MATCHING/**  
*ESEMPIO: ABBINAMENTO COLORI*

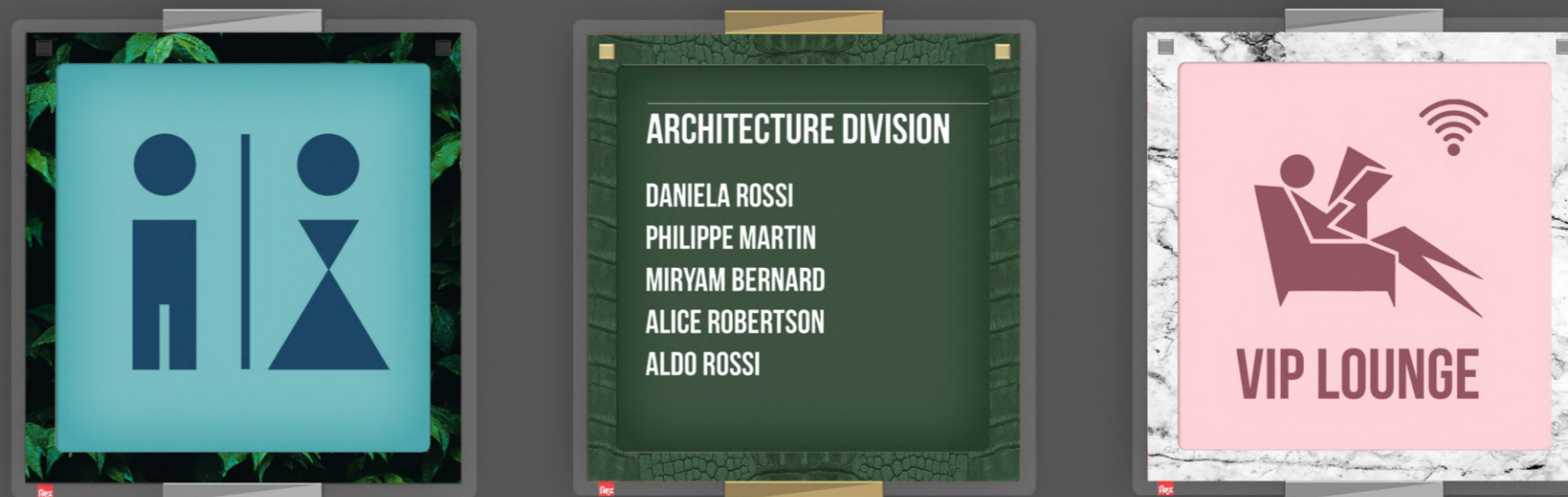

**A** ABS cover - CHROME, NICKEL, GOLD, SATIN GOLD, WHITE, BLACK/  
*Cover in ABS - CROMO, NICHEL, ORO, ORO SATINATO, BIANCO, NERO*



**B** Closing panel clip - CHROME, GOLD, WHITE, BLACK, GREY/  
*Clip di chiusura pannello - CROMO, ORO, BIANCO, NERO, GRIGIO*



**C** 200 gr Paper Poster/  
*Poster di carta - 200 gr*

**D** Digital printed mount - IMAGES, COLORS or TEXTURES/  
*Cornice stampata in digitale - IMMAGINI, COLORI o TEXTURES*



Model / Modello *Image*







**SIGN\_WALL – SYSTEM CHARACTERISTICS**  
*SIGN\_WALL - CARATTERISTICHE DEL SISTEMA*

The wall mounting SIGN LINE system (SIGN\_wall) consists of two metal blocks into which the panel is inserted and secured by means of tightening screws. Plastic covers are used to close the components.

*Il sistema SIGN LINE per il fissaggio a parete (SIGN\_wall) prevede due blocchetti in materiale metallico nei quali viene inserito il pannello bloccato per mezzo di viti di serraggio. A copertura e chiusura dei componenti vengono applicate delle cover in materiale plastico.*

**FIXING SYSTEM / SISTEMA DI FISSAGGIO**

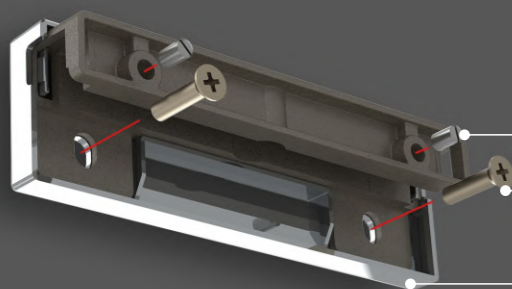

- Dowels for panel blocking  
*Grani per bloccaggio pannello*
- Screws for fixing system  
*Viti per fissaggio blocchetto*
- Wall fixing block with cover  
*Blocchetto di fissaggio completo di cover*





**SIGN\_WINDOW - SYSTEM CHARACTERISTICS**  
*SIGN\_WINDOW - CARATTERISTICHE DEL SISTEMA*

The window fixing SIGN LINE system (SIGN\_window) consists of two metal blocks into which the double-sided panel is inserted and locked with tightening screws. Plastic covers are used to close the components.

*Il sistema SIGN LINE per il fissaggio su vetro (SIGN\_window) prevede due blocchetti in materiale metallico nei quali viene inserito il pannello bifacciale bloccato con viti di serraggio. A copertura e chiusura dei componenti vengono applicate delle cover in materiale plastico.*

**FIXING SYSTEM / SISTEMA DI FISSAGGIO**

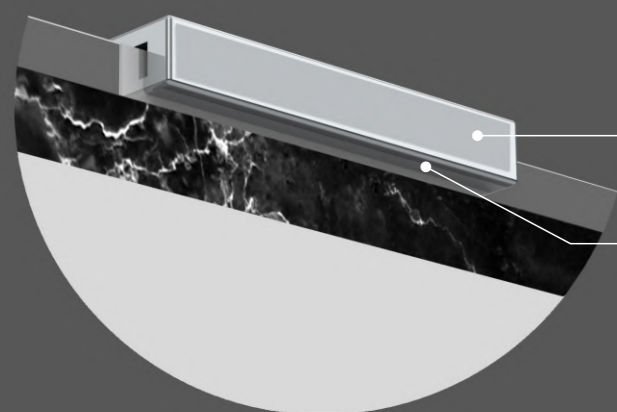

Double-sided strip for window fixing  
*Strip biadesiva per fissaggio a parete in vetro*

Wall fixing block with cover  
*Blocchetto di fissaggio completo di cover*





**SIGN\_HANG – SYSTEM CHARACTERISTICS**  
*SIGN\_HANG - CARATTERISTICHE DEL SISTEMA*

Depending on the format, the hanging fixing SIGN LINE system (SIGN\_hang) includes one or two metal blocks in which the double-sided panel is inserted and secured by means of tightening screws. Plastic covers are used to close the components.

*Il sistema SIGN LINE per il fissaggio a sospensione (SIGN\_hang) prevede, in base al formato, uno o due blocchetti in materiale metallico nei quali viene inserito il pannello bifacciale bloccato per mezzo di viti di serraggio. A copertura e chiusura dei componenti vengono applicate delle cover in materiale plastico.*

**FIXING SYSTEM / SISTEMA DI FISSAGGIO**

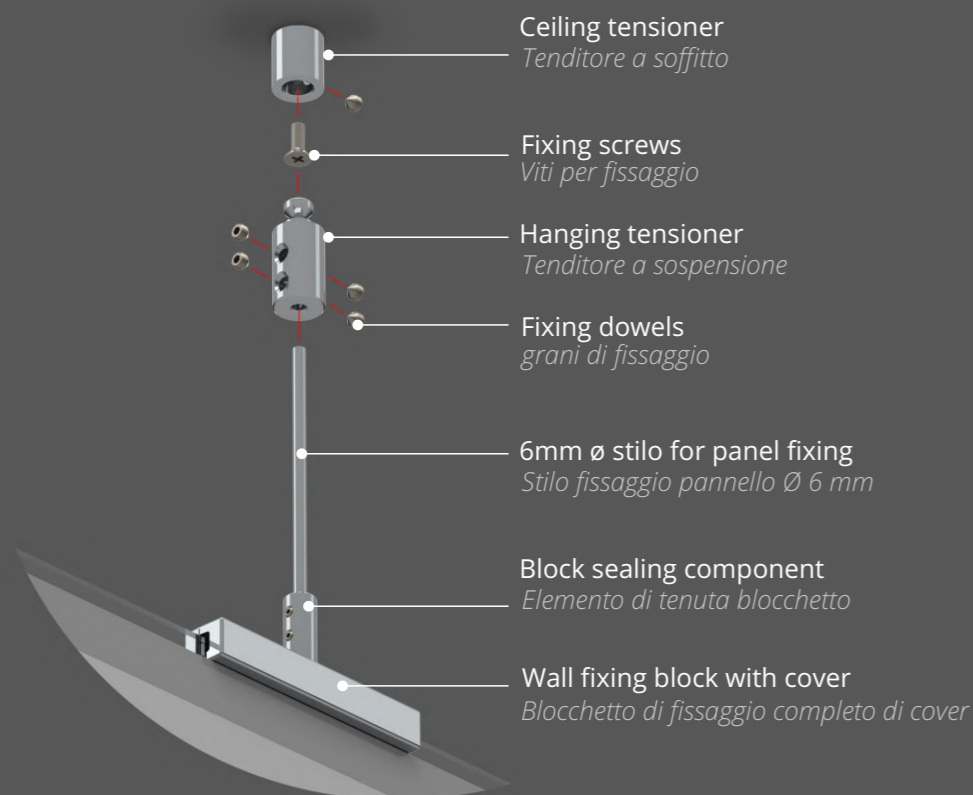



**SIGN\_FLAG - SYSTEM CHARACTERISTICS**  
*SIGN\_FLAG - CARATTERISTICHE DEL SISTEMA*

The wall-flag fixing SIGN LINE system (SIGN\_flag) consists of a metal block in which the double-sided panel is inserted and secured by means of tightening screws. Plastic covers are used to close the components.

*Il sistema SIGN LINE per il fissaggio a parete (SIGN\_flag) prevede un blocchetto in materiale metallico nel quale viene inserito il pannello bifacciale bloccato per mezzo di viti di serraggio. A copertura e chiusura dei componenti vengono applicate delle cover in materiale plastico.*

**FIXING SYSTEM / SISTEMA DI FISSAGGIO**

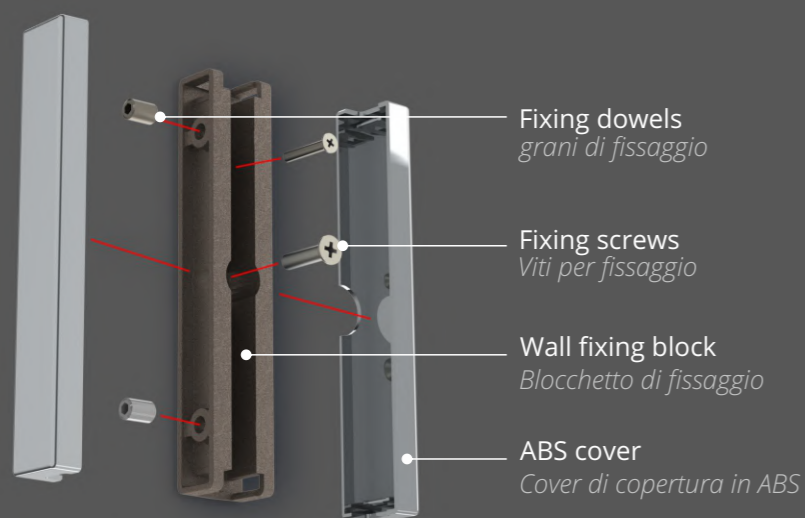



**SIGN\_DESK - SYSTEM CHARACTERISTICS**  
*SIGN\_DESK - CARATTERISTICHE DEL SISTEMA*

The desk self-supporting SIGN LINE system (SIGN\_desk) consists of a metal block in which the double-sided panel is inserted and secured by means of tightening screws. Plastic covers are used to close the components.

*Il sistema SIGN LINE auto portante da tavolo (SIGN\_desk) prevede un blocchetto in materiale metallico nel quale viene inserito il pannello bifacciale bloccato per mezzo di viti di serraggio. A copertura e chiusura dei componenti vengono applicate delle cover in materiale plastico.*

**FIXING SYSTEM / SISTEMA DI FISSAGGIO**

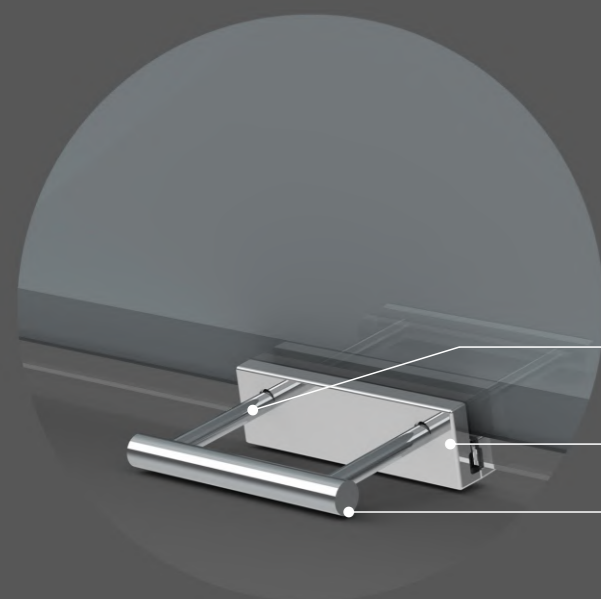

- Desk spacers  
*Distanziali da tavolo*
- Metal block with plastic covering  
*Blocchetto completo di cover*
- Horizontal pedestal  
*Piedistallo orizzontale*





## SIGN\_COMPOSITION - SYSTEM CHARACTERISTICS

### SIGN\_COMPOSITION - CARATTERISTICHE DEL SISTEMA

The SIGN LINE panels can part of compositions, fixed on vertical tensioners (cable or stilo) by horizontal clamps (single or double).

*I pannelli SIGN LINE possono essere configurati all'interno di composizioni con tenditori verticali e supportati da morsetti orizzontali (singoli o doppi).*

#### FIXING SYSTEM / SISTEMA DI FISSAGGIO

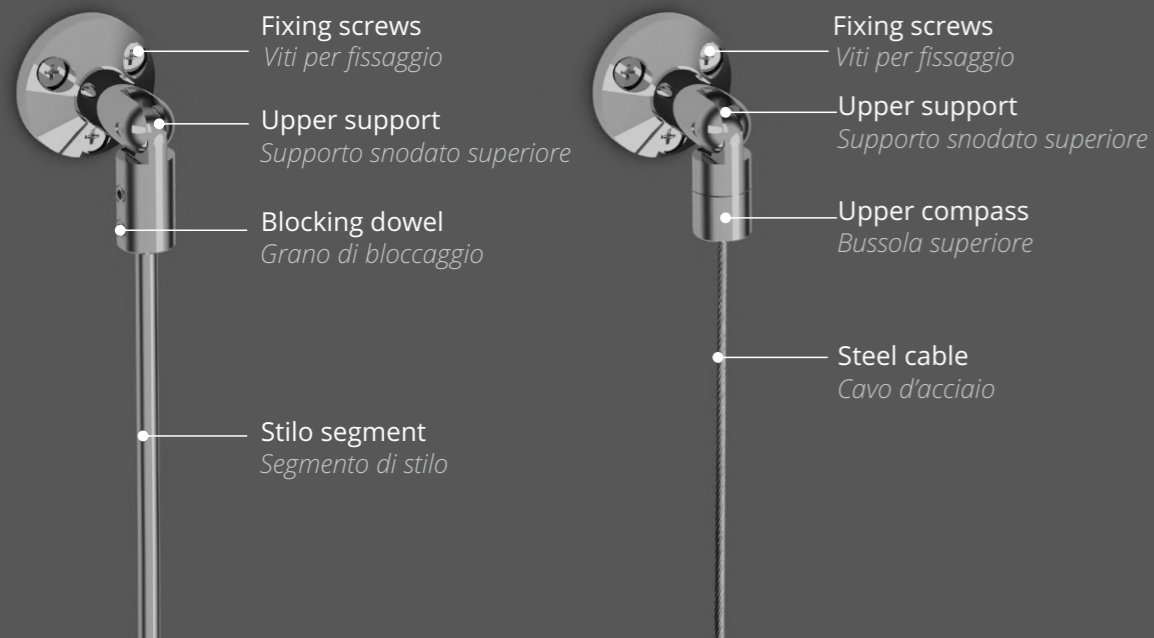



## SIGN POST – SYSTEM CHARACTERISTICS

### SIGN POST - CARATTERISTICHE DEL SISTEMA

SIGN POST is perfect in private and discreet environments, such as museums, art galleries and boutiques. The original SIGN POST is highly resistant post with rope that has been used in Italy and the world over since 1990 to guarantee the privacy of customers.

*La colonnina con cordone SIGN POST è caratterizzata dall'utilizzo, al posto del nastro estensibile, di raffinati cordoncini che enfatizzano l'eleganza e la leggerezza del prodotto, donando un design minimalista. Il blocchetto magnetico, caratteristico di SIGN POST, consente uno sgancio e aggancio rapido del cordoncino.*

#### FIXING SYSTEM / SISTEMA DI FISSAGGIO

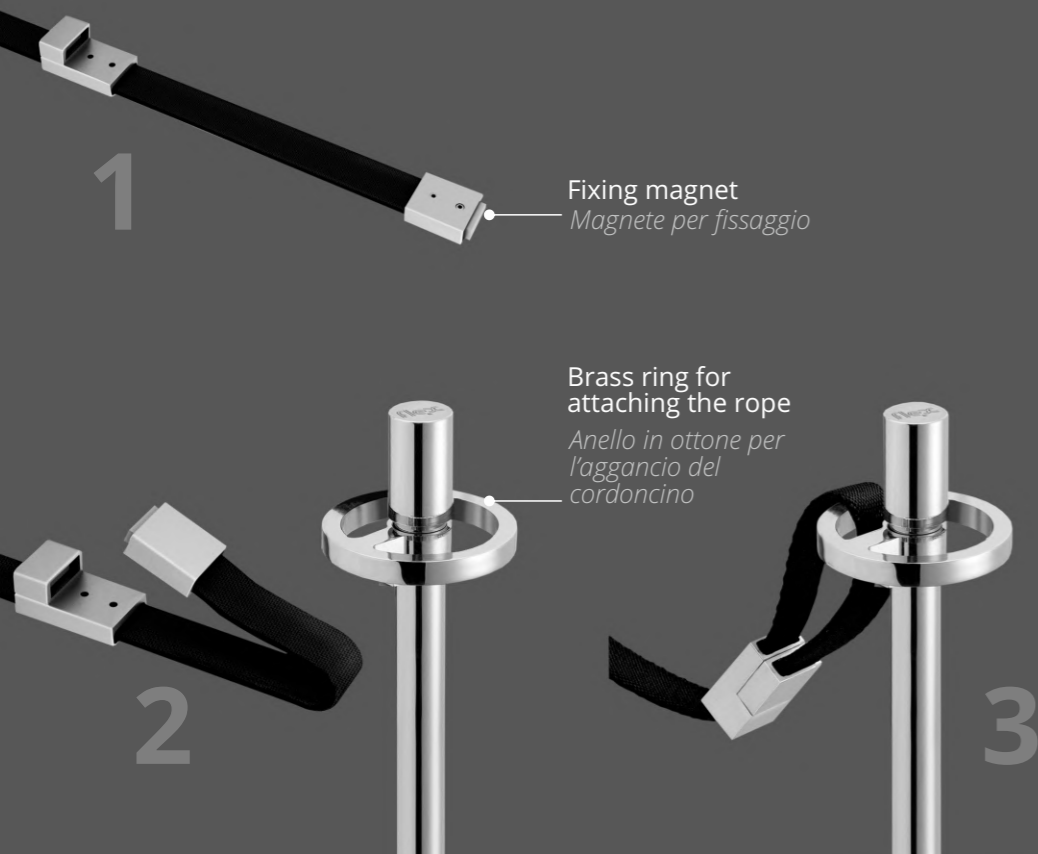



**INSTALLATION FLEXIBILITY/  
VERSATILITÀ D'INSTALLAZIONE**



**① SIGN\_window**

Panel fixed to glass/  
*Pannello fissato a vetro*

**② SIGN\_desk**

Self-supporting tabletop panel/  
*Pannello autoportante da tavolo*

**③ SIGN\_wall**

Panel fixed to the wall/  
*Pannello fissato a parete*

**④ SIGN\_Composition**

Panel fixed on cables or stilo/  
*Pannello fissato su cavi o stilo*

**⑤ SIGN\_flag**

Wall-flag fixing panel/  
*Pannello fissato a bandiera*

**⑥ SIGN\_hang**

Panel fixed to the ceiling/  
*Pannello fissato a soffitto*

**⑦ SIGN\_post**

Sign post with magnetic rope/  
*Sign post con cordone magnetico*



Examples of use / *Esempi di utilizzo*



Examples of use / *Esempi di utilizzo*



Examples of use / *Esempi di utilizzo*



Examples of use / *Esempi di utilizzo*

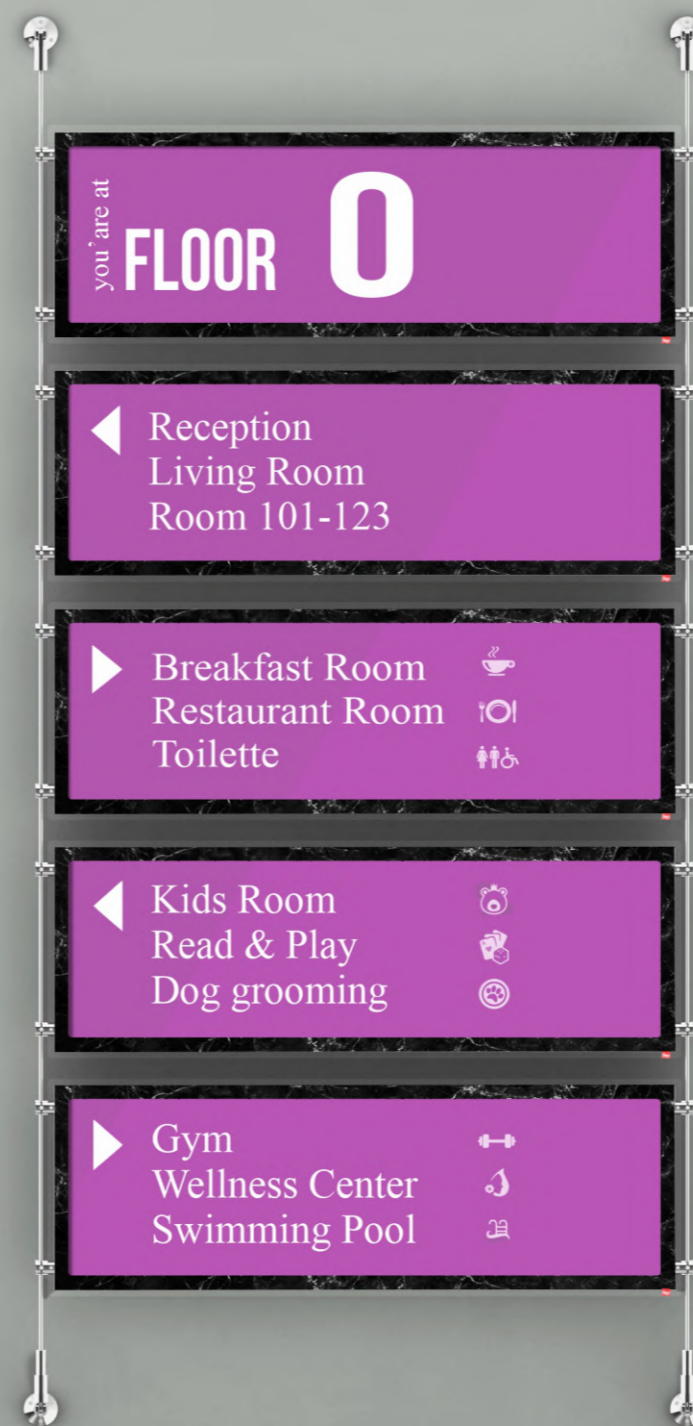

Examples of use / *Esempi di utilizzo*



Examples of use / *Esempi di utilizzo*



Examples of use / *Esempi di utilizzo*



Examples of use / Esempi di utilizzo





Since 1990 we have been changing the way people experience public spaces: faster pedestrian flows, clear information, impactful communication.

We bring light, color and beauty to all environments, making them better organized and more pleasant.

**Get in touch with us to find out more!**

*Dal 1990 cambiamo il modo in cui le persone vivono i luoghi pubblici: flussi pedonali più veloci, informazioni chiare, comunicazione d'impatto.*

*Portiamo luce, colore e bellezza in tutti gli ambienti, rendendoli meglio organizzati e più piacevoli.*

**Contattaci per saperne di più!**





**Flex s.r.l**  
via Gaetano Bargnani, 11  
25135 Brescia (BS), Italy  
info@flex.it  
tendiflex.it  
flex.it

